

# Display Planner & Price Guide



# Display Your Best.™

**ExpoStar**®

Displays And Graphics

TRADESHOW Display Systems  
Johnson City, TN

**1-888-EXHIBIT**  
(1-888-394-4248)

local: 423-952-0770

sales specials:  
**displayHQ.com**

# CONTENTS

- 3 PANELS
  - PANEL SPECIFICATIONS
  - PALLADIAN STRIPES
  - STANDARD PANEL SIZES
- 4 6' TABLETOPS
- 5 MINI-TABLETOPS
- 8' TABLETOPS
- 6 DISPLAYS
  - 6 READY•SET•SHOW®
  - 8 PALLADIAN®
  - 10 THE MONTICELLO®
  - 12 THE REGENCY®
  - 14 CUSTOM CONFIGURATIONS
  - 16 THE RENAISSANCE®
  - 17 MAGICPAK BANNER DISPLAYS
  - SHOWSTYLE BRIEFCASE
  - PRESENTATION SYSTEM
- 18 PODIUMS, COUNTERS
  - KITS
  - DOOR ASSEMBLIES
  - RECESSED COUNTERS
  - HEADERS
- 19 CUSTOM COMPONENTS
  - LIGHTS
  - LITERATURE HOLDERS
- 20 ACCESSORIES
  - COUNTERTOPS
  - TABLE ACCESSORIES
  - SKIRTS
  - COVERINGS
  - SKIRT CLIPS
  - SKIRT HANGERS
  - VELCRO® HOOK TAPE
  - STACKING GUIDES
  - JOINING STRIPS
- 21 FABRICS
  - PRODUCT LINES
  - CUT YARDAGE
  - CUSTOM STRIPING
  - CASES
  - MOLDED SHIPPING CASES
  - GRAPHICS CASES
  - ROUND CASES
  - CANVAS CARRY BAGS
- 22 GRAPHICS
  - MEGAMURAL
  - LARGE FOMAT PRINTING
  - STRIP SIGNS
  - HEADER GRAPHICS
- 23 GRAPHICS SPECIFICATIONS

## ABOUT EXPOSTAR DISPLAYS

Hardly a trade show opens these days without evidence of the innovation and excellence of ExpoStar Displays somewhere on the show floor.

From the distinctive elegance of our trademarked arch-top folding displays to the compelling presence of our unique patented column design, ExpoStar's powerful portables provide display solutions to tradeshow challenges for clients large and small all across America.

When it comes to powerful portable displays that stop people in their tracks on the trade show floor, there's only one ExpoStar.

### Large Format Color Graphics

ExpoStar offers a full service graphics department with a staff of talented designers to help in all phases of planning and designing your display. Using state-of-the-art graphic computers and large format color printers we can work with existing artwork or create spectacular murals from your slides, prints or artwork.

### Shipping Information

Our production time is one of the fastest in the industry and your shipment is monitored every step of the way with our UPS Maxitrac ground computer terminal. Most display orders ship 10 working days from the receipt of order with a 50% deposit. For complex graphics please allow 3 weeks to avoid rushing the design process. Please figure shipping times when placing your order. Next day, 2nd day or 3rd day shipping is also available.

## EXPOSTAR MAKES ORDERING EASY

Whether you're an old hand at working with trade show displays, or this is the first time you've even thought about it, ExpoStar makes ordering easy.

Your time is valuable, so look over the material in this guide carefully. It will help you as we move through the selection and design process, helping you be better informed in every decision you make along the way.

This guide is designed to make the selection process simple by grouping the various styles of displays together. Custom configurations or variations of the standard designs are available which make your choices limitless.

Working with our Authorized Dealers ExpoStar maintains a network of authorized dealers all across the country. This gives you excellent, at-your-fingertips service as you select the ExpoStar display system that best meets your needs and design the graphics that will ultimately tell your story.

To locate the dealer nearest you, give us a call at 1-888-EXHIBIT.



All ExpoStar Displays are built by skilled craftsmen using only the finest display materials available. All materials and workmanship are guaranteed against defects for five years from the original date of purchase.

## PANEL SPECIFICATIONS

### HOW TO USE THIS GUIDE

Displays by ExpoStar offer you maximum flexibility. Each display in this guide features several versions of that system most often chosen by our customers. In most cases, that display or a slightly altered version of that system will fit your needs. However, because of the component-based concept of all ExpoStar displays, you have complete flexibility to create any kind, style or size of display you need. Just ask your authorized dealer to help you decide which ExpoStar solution best suits your tradeshow needs.

### ABOUT OUR GRAPHICS SERVICES

As well as specializing in top-quality display kits and accessories, ExpoStar offers a fully staffed design department to assist you with your graphic needs. We gladly provide quotes for graphic services and materials for your display.

Our design staff has a wide range of capabilities including:

- Assisting you in designing your display using your existing promotional materials.
- Creating high-end computer-generated graphics from photographs, illustrations and text, such as our large MegaMural Graphic designs. (pages 22 & 23)
- Creating header graphics and reproducing logos for corporate identity.
- Mounting and laminating photographs and artwork.
- Producing signage and text panels for your display panels in vinyl or large format color printers.

Give us a call for more information about our services. We will locate the dealer nearest you for convenient service. ExpoStar offers a turnkey approach to portable displays.

*The following size specifications define ExpoStar's basic and Arch-Top display panels (see next section— Displays). ExpoStar also provides customized components, like columns, curve panels, towers, bridges and counters. Combine these components with our basic panels to increase the visual impact of your display.*

### BASIC PANELS

ExpoStar's standard displays are based on a uniform size panel. Using these panels as building blocks, we can construct any configuration you need for your display.

**Single Panel**  
22" x 44", 4.5 lbs.

**Double Panel**  
44" x 44", 9 lbs.

**3-Panel**  
68" x 44", 13.5 lbs.

**4-Panel**  
90" x 44", 18 lbs.

**5-Panel**  
114" x 44"  
23 lbs.

**6-Panel**  
136" x 44"  
27 lbs.

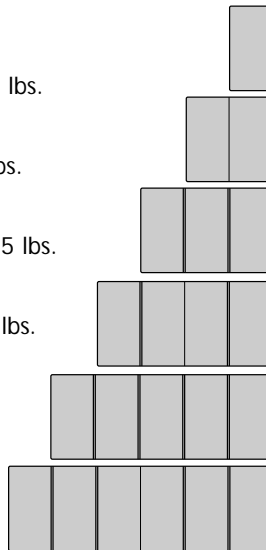

### ARCH-TOP PANELS

All standard Arch-Top displays have a 2" accent stripe and header stripe on front side, solid color on back. Stripes are optional on back.

The following chart is provided to assist in placement and location of graphics.

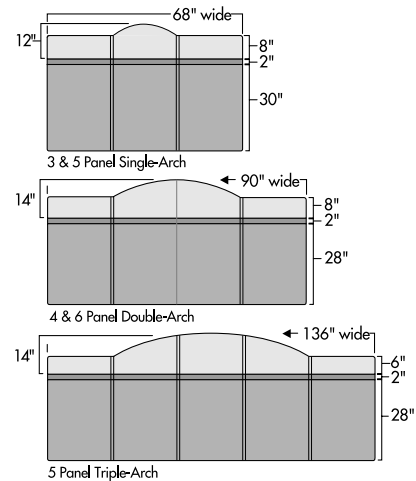

For example:

A 5-Panel Tabletop Display

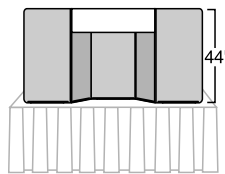

Single panel height 44"

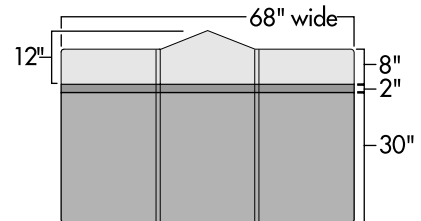

A 10-Panel

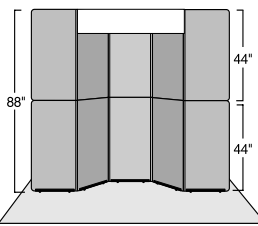

Stacked panel height 88"

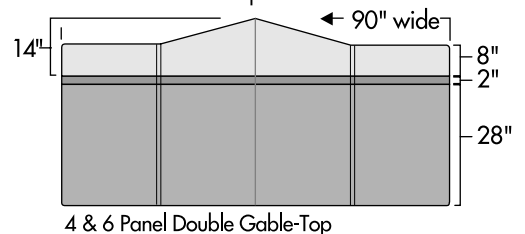

4 & 6 Panel Double Gable-Top

Prices and specifications subject to change without notice

# 6' TABLETOP DISPLAYS

## ABOUT OUR TABLETOPS

- ExpoStar offers a variety of table top styles and sizes. All are light weight, versatile, set up quickly and ship in one case.
- Bases can be added to tabletops to create a freestanding display.
- ExpoStar introduces the new Rollaflex design featuring ExpoStar's patented rollable columns with rollable center panel.
- Standard Fabric prices include Tempo® or Showtime® fabrics. Fabric Upgrade prices listed include Front Runner® or Prelude® fabric on front side. Add \$10 per panel upgrade on back.

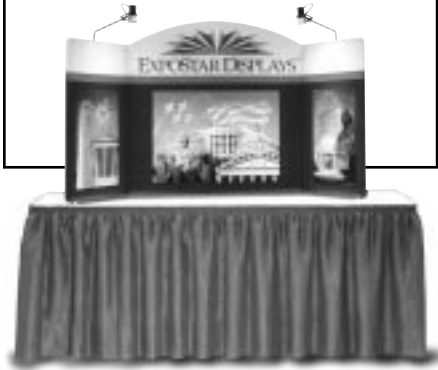

### EPT•04A2 - Palladian

Fits 6' table.

Add base and columns to create 10' Monticello.  
page 9

\* Palladian Arch-top display shape and silhouette are protected by trademark #'s 2068109, 2048424, 2048423, 2048441.

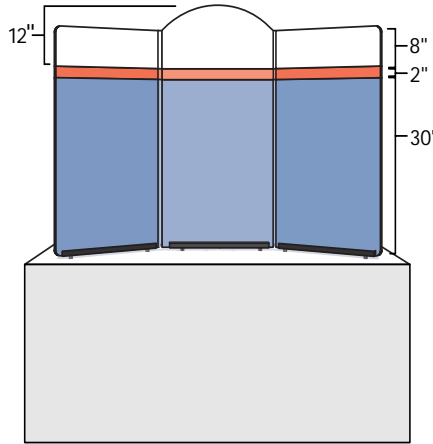

### EPT•03A1 - Palladian

\$595 Standard Fabric  
\$625 Fabric Upgrade  
page 9

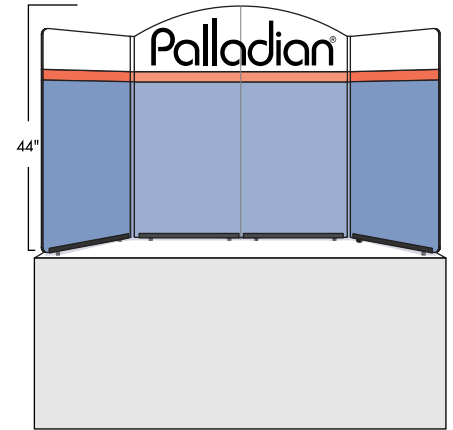

### EPT•04A2 - Palladian

\$795 Standard Fabric  
\$835 Fabric Upgrade  
page 9

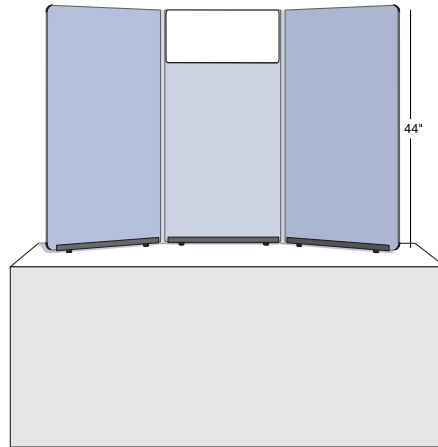

### RSS•3T - Ready•Set•Show!

\$395 Standard Fabric  
\$425 Fabric Upgrade  
page 7

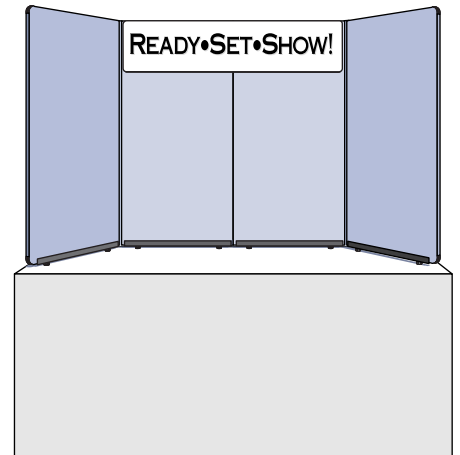

### RSS•4T - Ready•Set•Show!

\$595 Standard Fabric  
\$635 Fabric Upgrade  
page 7

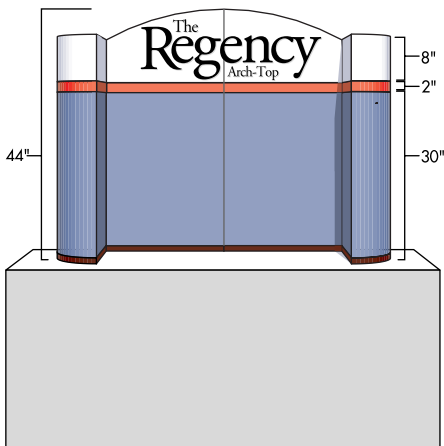

### ERT•44A2 - Regency Arch-Top

\$895 Standard Fabric  
\$955 Fabric Upgrade  
page 12

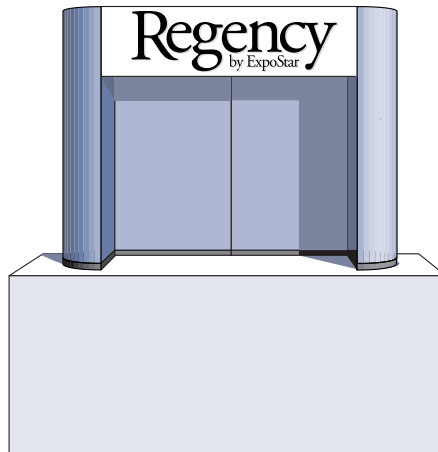

### ERT•44T - Regency

\$895 Standard Fabric  
\$955 Fabric Upgrade  
page 12

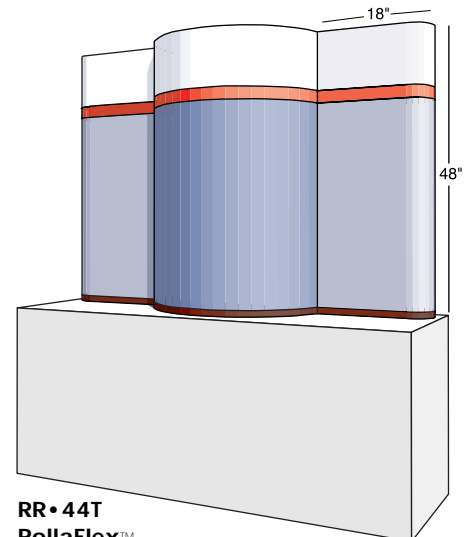

### RR•44T

**RollaFlex™**  
\$795 Standard Fabric  
\$875 Fabric Upgrade

## MINI-TABLETOP DISPLAYS



**EPMT-03A1 - Mini Palladian\***

\$475 Standard Fabric

\$495 Fabric Upgrade

page 9 \*Optional Padded Cordura Bag \$150

### ABOUT MINI-TABLETOPS

- Mini-Tabletops are ideal for recruiters, sales reps and presentations.
- Panel sizes 18" x 36".  
Entire tabletop packs into case 20" x 36" x 4".
- Total weight with case is 20lbs.
- Also available as 5-panel or 6-panel tabletops.



**RSS4MT- Mini Ready•Set•Show\***

\$495 Standard Fabric

\$535 Fabric Upgrade

page 7 \*Optional Padded Cordura Bag \$150

## 6' ROLLAFLEX DISPLAYS

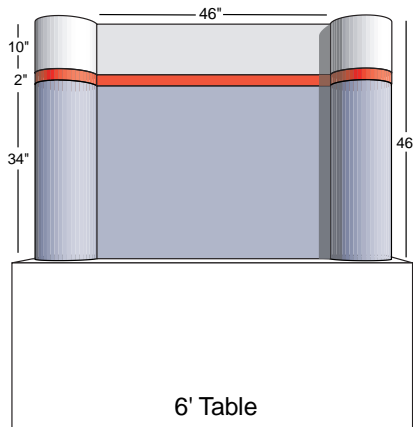

**ERF•46T - Rollaflex 46"**

\$695 Standard Fabric

\$735 Fabric Upgrade

Includes 12"x 50" Smartpak Graphics Case

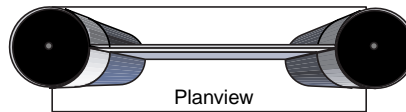

### ABOUT ROLLAFLEX

- Rollaflex design features ExpoStar's patented rollable columns with rollable center panel.
- Entire unit fits in 12" x 38" or 50" Smartpak Graphics Case.
- Rollaflex can be covered with fabric, flexible marble laminate or large format mural graphics.  
Graphics quoted separately

Optional 75w Halogen Spotlights

\$85 each

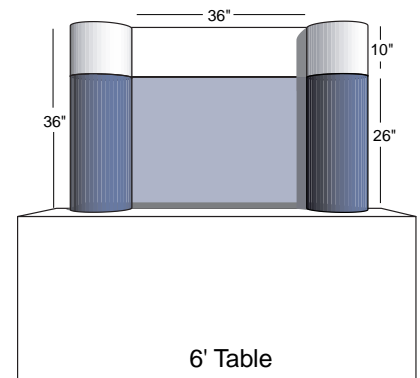

**ERF•36T - Rollaflex 36"**

\$595 Standard Fabric

\$625 Fabric Upgrade

Includes 12"x 38" Smartpak Graphics Case

## 8' TABLETOP DISPLAYS

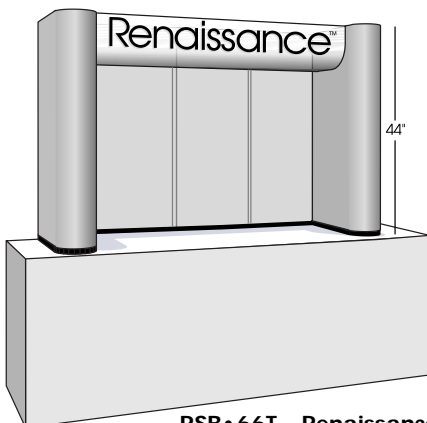

**RSB•66T - Renaissance**

\$925 Standard Fabric

\$995 Fabric Upgrade

page 16

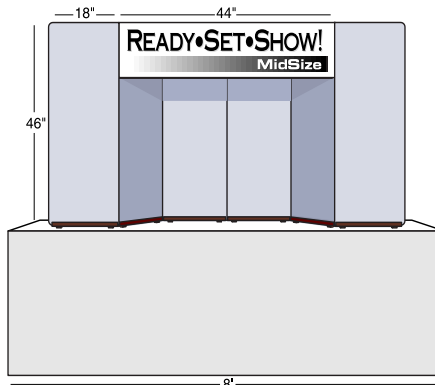

**RSS•6MS - Mid-Size Tabletop**

\$695 Standard Fabric

\$740 Fabric Upgrade

page 7

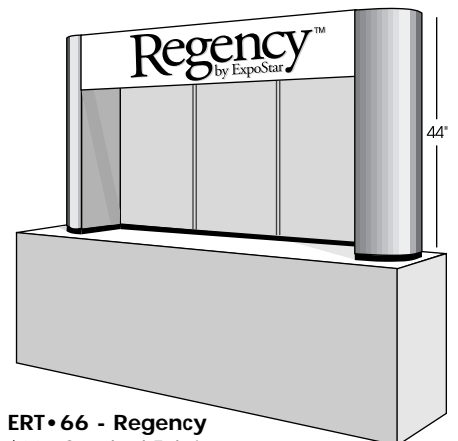

**ERT•66 - Regency**

\$935 Standard Fabric

\$995 Fabric Upgrade

page 13

FEATURED DISPLAYS

**12-Panel Curve Freestanding Ready·Set·Show!**

This 12-panel display with curved end caps is set up in a curved configuration. Shown with a continuous wrap header, five 75w halogen lights, pictured with standard corrugated shipping cartons (included).

RSS•12CH	\$2295
75w Halogen lights (\$99 each)	\$495
Fabric Upgrade (Front Only)	\$160
Total price as shown	\$2950

**12-Panel Freestanding with Backlit Header**

(Bottom right)

This 12-panel Ready·Set·Show! Features a 12" x 60" backlit header, 3 bulb lightbar and curved end caps. Shown with optional 10" and 2" accent stripes with matching 4-panel counter. Ships in three cartons.

RSS•12C	\$2495
Optional 10" & 2" stripes	\$240
Fabric Upgrade (Front Only)	\$160
ED4-40 Counter (As Shown)	\$855



RSS•3T

**3-Panel Tabletop**

(Pictured above)

This lightweight tabletop fits a 6' table. Includes blank header and corrugated carton. Ship wt. 24 lbs.

RSS•3T	\$395
Fabric Upgrade	\$425

Also available in Mini-Tabletop version with 18" x 36" panels. See page 5.



RSS•12CH



RSS•12C

# READY-SET-SHOW® DISPLAYS

## ABOUT READY • SET • SHOW!

- All displays include blank header.
- The required number of corrugated shipping cartons are provided with each display kit. Ship weight includes corrugated cartons.
- Create 20' or larger displays by joining any combination of free-standing units with fabric-covered joiner strips.

\*Standard Fabric prices include Tempo® or Showtime® Fabric. Fabric Upgrade prices listed include Front Runner® or Prelude® fabric on front side. Add \$10 per panel upgrade on back.

### The Mini-Tabletop

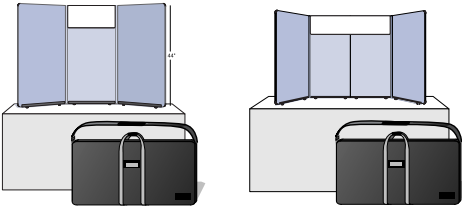

**RSS•3MT**  
3-Panel Mini-Tabletop  
8"x 18" radius header,  
18"x 36" panels, 25 lbs.  
\$345 Standard Fabric  
\$375 Fabric Upgrade\*  
Cordura® case add \$150

**RSS•4MT**  
4-Panel Mini-Tabletop  
8"x 36" radius header,  
one carton, 30 lbs.  
\$495 Standard Fabric  
\$535 Fabric Upgrade\*  
Cordura® case add \$150

### Mid-Size Tabletop

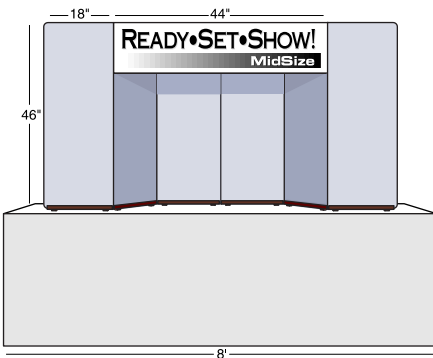

**RSS•6MS - Mid-Size Tabletop**  
Our Mid-Size tabletop comes with 18" wide panels. This 6-panel display with backlit header is ideal for an 8' table. Includes light bar and corrugated case. Ship wt. 35 lbs.  
\$695 Standard Fabric  
\$740 Fabric Upgrade\*

### Tabletop

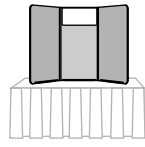

**RSS•3T**  
3-Panel Tabletop  
10"x 22" radius header,  
one carton, 25 lbs.  
\$395 Standard Fabric  
\$425 Fabric Upgrade\*

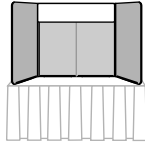

**RSS•4T**  
4-Panel Tabletop  
10"x 44" radius header,  
one carton, 30 lbs.  
\$595 Standard Fabric  
\$635 Fabric Upgrade\*

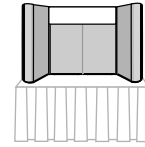

**RSS•4TC**  
4-Panel Tabletop • Curve  
10"x 44" radius header,  
one carton, 35 lbs.  
\$795 Standard Fabric  
\$845 Fabric Upgrade\*

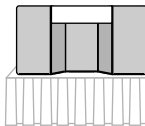

**RSS•5T**  
5-Panel Tabletop  
12"x 44" backlit header,  
one carton, one light bar,  
37 lbs.  
\$895 Standard Fabric  
\$955 Fabric Upgrade\*

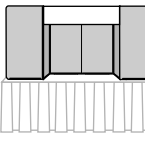

**RSS•6T**  
6-Panel Tabletop  
12"x 44" backlit header,  
one light bar, one carton,  
42 lbs.  
\$995 Standard Fabric  
\$1055 Fabric Upgrade\*

### Freestanding

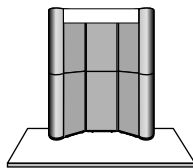

**RSS•6C**  
6-Panel Freestanding  
12" x 44" backlit header,  
one light bar, two carton,  
35 lbs.  
\$1395 Standard Fabric  
\$1495 Fabric Upgrade\*

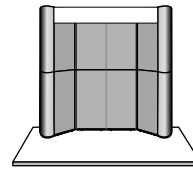

**RSS•8C**  
8-Panel Freestanding  
12" x 69" backlit header,  
light bar curved end caps,  
two cartons, 35 lbs. each.  
\$1775 Standard Fabric  
\$1895 Fabric Upgrade\*  
\$1435 without curves

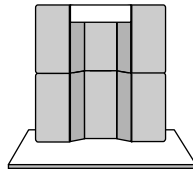

**RSS•10**  
10-Panel Freestanding  
12"x 44" backlit header,  
light bar, two carton,  
33 lbs. each.  
\$1695 Standard Fabric  
\$1795 Fabric Upgrade\*  
(add \$380 for curves)

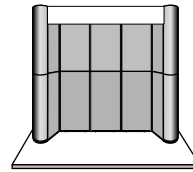

**RSS•10C**  
10-Panel Freestanding  
12"x 80" backlit header,  
two light bars, curved end  
panels, two cartons,  
37 lbs. each.  
\$2295 Standard Fabric  
\$2435 Fabric Upgrade\*

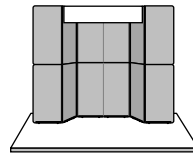

**RSS•12**  
12-Panel Freestanding  
12"x 60" backlit header,  
light bar, two cartons,  
40 lbs. each.  
\$1995 Standard Fabric  
\$2115 Fabric Upgrade\*

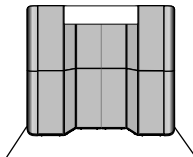

**RSS•12C**  
12-Panel Freestanding  
12"x 60" backlit header,  
lightbar, curves, two  
cartons, 45 lbs. each.  
\$2495 Standard Fabric  
\$2655 Fabric Upgrade\*

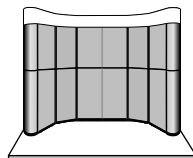

**RSS•12CH**  
12-Panel with Curves  
12"x 180" vinyl header,  
curves, two cartons,  
41 lbs. each.  
\$2295 Standard Fabric  
\$2455 Fabric Upgrade\*

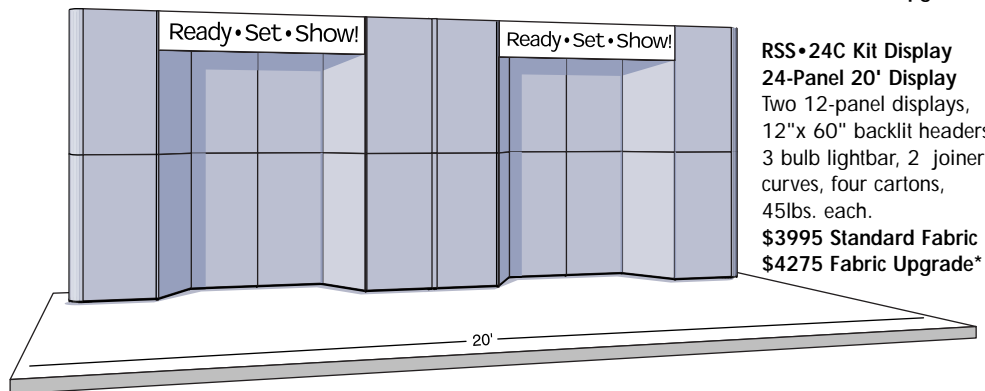

**RSS•24C Kit Display**  
24-Panel 20' Display  
Two 12-panel displays,  
12"x 60" backlit headers,  
3 bulb lightbar, 2 joiner strips,  
curves, four cartons,  
45lbs. each.  
\$3995 Standard Fabric  
\$4275 Fabric Upgrade\*

FEATURED DISPLAYS

**12-Panel Palladian**

Our most popular freestanding display, this 12-panel Palladian fills a 10' wide booth and can also be used as a tabletop display on a 6' or 8' table. Shown with standard 2" accent stripe, optional 1" accent stripe and 75w halogen spotlights. Pictured is a curved counter with matching accent stripes.

EPF•12A2C	\$2595
1" Accent stripe	\$120
Fabric Upgrade ( <i>display</i> )	\$2695
Curved podium ( <i>with stripes</i> )	\$1005

**8-Panel Freestanding Palladian**

(Bottom right)

8-panel freestanding Palladian with curved end caps. Pictured with 75w halogen lights, literature shelf, 6" deep product shelf and molded shipping cases.

EPF-08A2C	\$1895
Fabric Upgrade ( <i>front only</i> )	\$1995
Wireform Halogen lights ( <i>each</i> )	\$99
Literature shelf 12"x 20" ( <i>each</i> )	\$45
Product shelf ( <i>each</i> )	\$45
Molded cases with wheels ( <i>each</i> )	\$295



EPF•12A2C



**4-Panel Tabletop Palladian**

This 4-panel tabletop is shown on a 6' table. As shown with 8-panel on right, this display can also be used as a freestanding display.

EPT•04A2	\$795
Fabric Upgrade ( <i>front only</i> )	\$835
Step shade spotlights ( <i>each</i> )	\$85

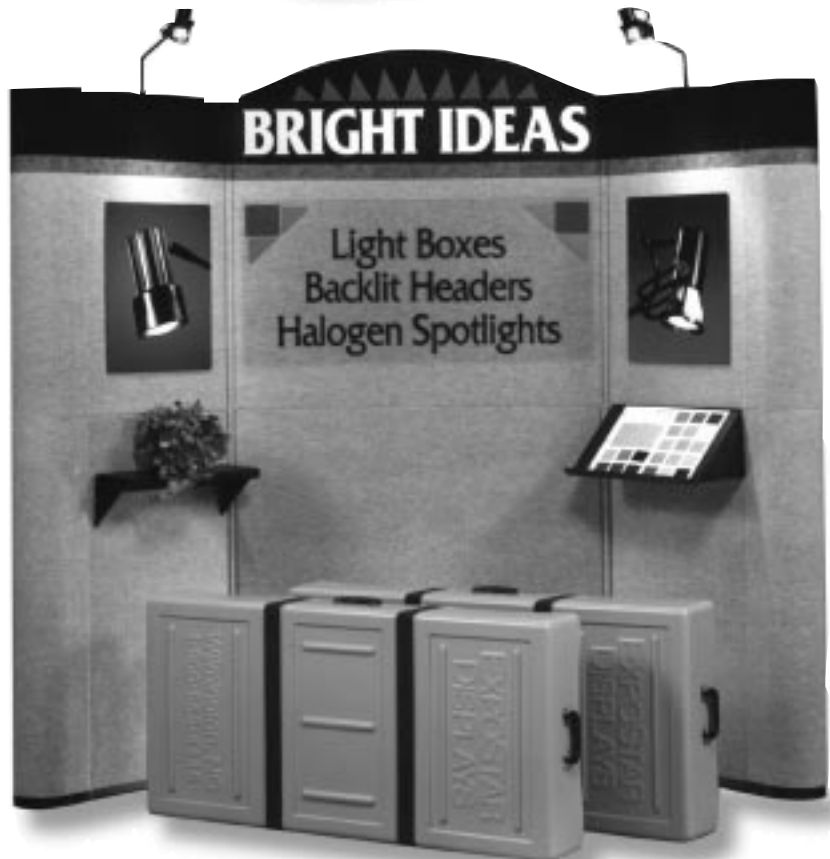

EPF•08A2C

## ABOUT THE PALLADIAN

■ All Palladian displays feature ExpoStar's trademarked Arch-Top, creating an ideal area to highlight company name or logo.

Standard Fabric prices include Tempo® or Showtime® Fabric. Fabric Upgrade prices listed include Front Runner® or Prelude® fabric on front side. Add \$10 per panel upgrade on back.

\*ExpoStar Arch-Top Displays, Trademark #'s 2068109, 2048424, 2048423, 2048441



### Mini-Palladian Tabletop

Panel size 18" wide x 36" to top of arch

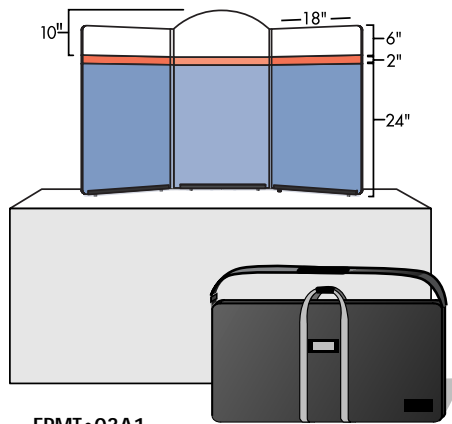

**EPMT•03A1**

**3-Panel Mini-Tabletop**

Clear arched header, one carton, 25 lbs.

**\$475 Standard Fabric**

**\$495 Fabric Upgrade\***

With Cordura® nylon case, add \$150

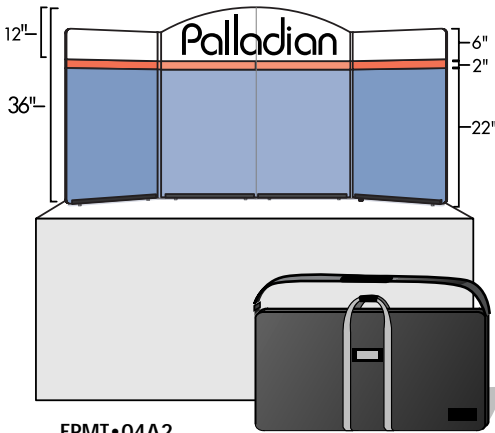

**EPMT•04A2**

**4-Panel Mini-Tabletop**

Clear arched header, one carton, 30 lbs.

**\$635 Standard Fabric**

**\$675 Fabric Upgrade\***

With Cordura® nylon case, add \$150

## STANDARD PALLADIAN STRIPE SPECIFICATIONS

All Palladian Arch-Top Displays feature Palladian Arch-Top header stripe and a 2" accent stripe and on front side, solid color on back. Stripes on the back side of the display are optional.

Stripes may be added or deleted as desired. Custom striping is also available. Standard Fabric, Tempo or Showtime may be combined with Upgrade Fabric, FrontRunner or Prelude, for contrasting fabric textures.

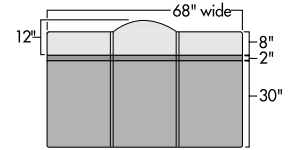

3 & 5 Panel Single-Arch

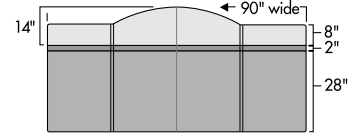

4 & 6 Panel Double-Arch

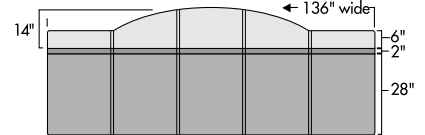

5 Panel Triple-Arch

### Tabletop

Panel size 22" x 44" to top of arch

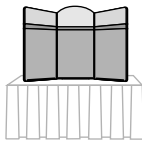

**EPT•03A1**

**3-Panel Tabletop**

Clear arched header, one carton, 25 lbs.

**\$595 Standard Fabric**

**\$625 Fabric Upgrade\***

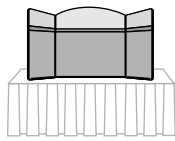

**EPT•04A2**

**4-Panel Tabletop**

Clear arched header, one carton, 30 lbs.

**\$795 Standard Fabric**

**\$835 Fabric Upgrade\***

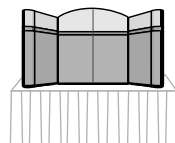

**EPT•04A2C**

**4-Panel Tabletop•Curve**

Clear arched header, one carton, 30 lbs.

**\$995 Standard Fabric**

**\$1055 Fabric Upgrade\***

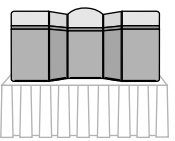

**EPT•05A1**

**5-Panel Tabletop**

Clear arched header, one carton, 33 lbs.

**\$995 Standard Fabric**

**\$1045 Fabric Upgrade\***

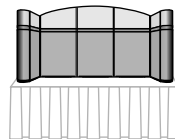

**EPT•05A3C**

**5-Panel Tabletop**

Clear arched header, curved end caps, one carton, 38 lbs.

**\$1295 Standard Fabric**

**\$1365 Fabric Upgrade\***

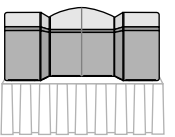

**EPT•06A2**

**6-Panel Tabletop**

Clear arched header, one carton, 41 lbs.

**\$1195 Standard Fabric**

**\$1255 Fabric Upgrade\***

### Freestanding

Single panels 22" x 44" stack to height of 88".

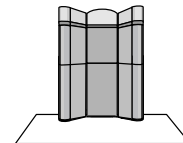

**EPF•06A1C**

**6-Panel Freestanding**

Clear header, one carton, curved end caps, 45 lbs.

**\$1475 Standard Fabric**

**\$1575 Fabric Upgrade\***

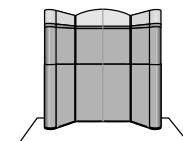

**EPF•08A2C**

**8-Panel with Curves**

Clear header, two cartons, 35 lbs. each.

**\$1895 Standard Fabric**

**\$1995 Fabric Upgrade\***

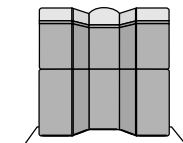

**EPF•10A1**

**10-Panel Freestanding**

Clear header, two cartons, 35 lbs. each.

**\$1795 Standard Fabric**

**\$1895 Fabric Upgrade\***

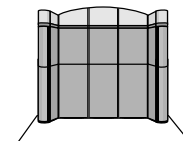

**EPF•10A3C**

**10-Panel with Curves**

Clear header, curved end panels, two cartons, 36 lbs. each.

**\$2295 Standard Fabric**

**\$2395 Fabric Upgrade\***

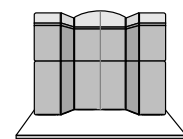

**EPF•12A2**

**12-Panel Freestanding**

Clear header, two cases, 42 lbs. each.

**\$2195 Standard Fabric**

**\$2295 Fabric Upgrade\***

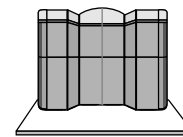

**EPF•12A2C**

**12-Panel with Curves**

Clear header, curved end panels, two cartons, 47 lbs. each.

**\$2595 Standard Fabric**

**\$2695 Fabric Upgrade\***

# MONTICELLO® DISPLAYS



MC•16C4-A2

## MC•16C4A2 - 20' Monticello ▲

This 20' Monticello features ExpoStar's trademark Arch-Top with accent stripes on the base of the display. MegaMural graphics created by compositing photographs and text. Shown with four 300w halogen lights. Curved counters striped to match display. Ships in four cases and one 16" diameter round shipping case (including counters).

MC•16C4A2 - 20' Monticello \$4695  
Fabric Upgrade \$280

### (Optional Features Additional)

Stripes on base of display \$240  
300w wall washers (each) \$145  
Curved counters as shown \$995  
Optional molded cases SPC \$1405  
(4) HDSC•W \$1180  
(1) SPC - 16/50 graphics case \$225  
(Contains entire unit as shown, graphics not included)



MC•8C2

▲ This Monticello can easily be used as a 10' display. The 4-panel center section also works as a tabletop display.

MC•8C2-A2 - 10' Monticello \$2395  
Stripes on base of display \$220  
Fabric Upgrade on unit \$160  
300w wall washers (each) \$145  
(1) HDSC•W \$295  
(1) 12/50 SPC \$175

## MC•16C4-BL 20' Monticello ▼

Includes four columns, 12" and 2" accent striping on header and base, solid color on back, 12" x 80" backlit header and 2 bulb lightbar. Ships in four cartons, 50 lbs. each. Center section can be used as 10' exhibit.

**\$5395 Standard Fabric**

**\$5695 Fabric Upgrade**

*Optional Features:*

**\$680 Marble columns (\$85 per column section)**

**\$815 Molded case upgrade two flat molded cases**

*HDSC-W, one 16"x 50" Smartpak Graphics case.*

**\$4500 Mural Graphic Includes layout, design, scans, print, mount and laminate (approximate)**

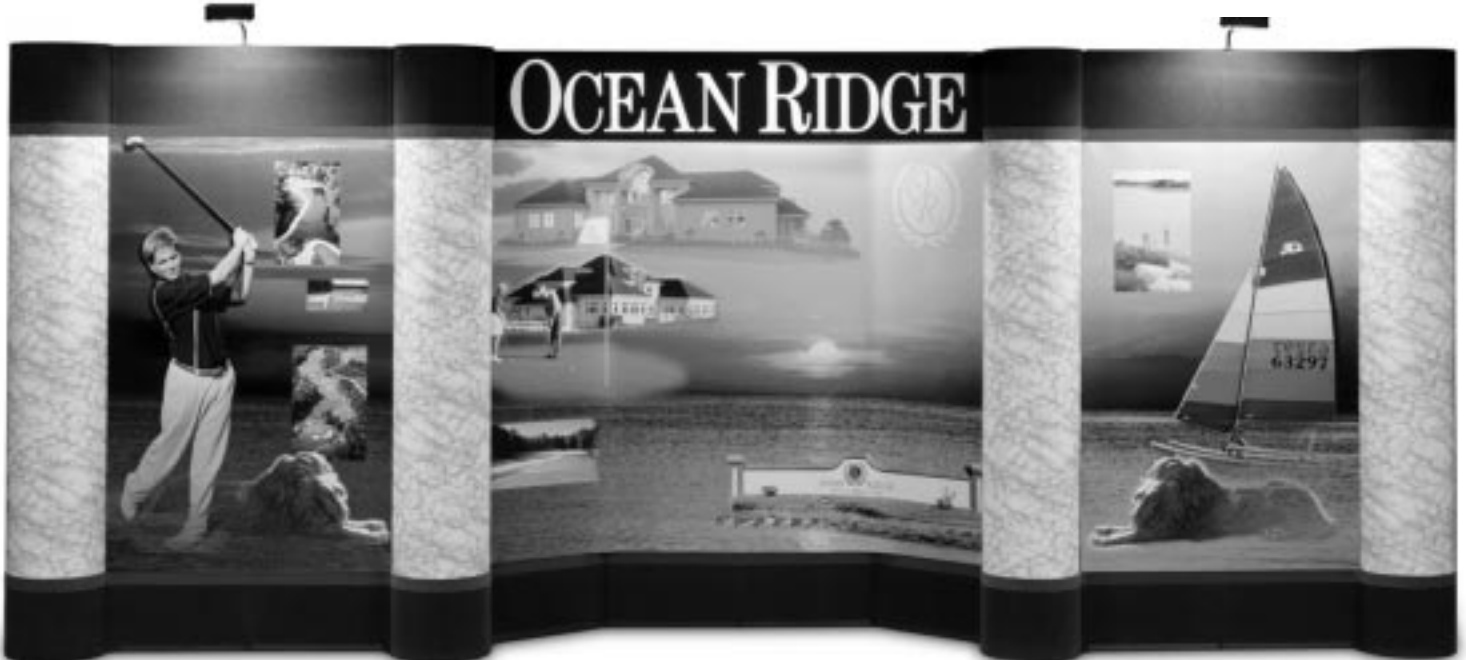

# MONTICELLO® DISPLAYS

## ABOUT THE MONTICELLO

- The Monticello features ExpoStar's unique patented one-piece rollable columns\*.
- Available with backlit headers or our trademark Arch-Top\* header. See examples at right.
- The *Standard Fabric* price includes fabric covering front and back of display. The *Fabric Upgrade* listing indicates Front Runner® or Prelude®, fabric upgrade on front and standard fabric® on back. For fabric up-grade on back, add \$10 per panel.
- Standard striping includes inlaid header stripe and 2" accent stripe on front. Stripes may be added as desired. See *base stripes* as example.

### MC•16C4-A2 20' Monticello ▶

Includes four columns, 2" accent stripe and header stripe front side, solid color on back. Clear Lexan® header. Ships in three cartons, 50 lbs. each. Can also be used as 8-panel freestanding or 4-panel tabletop.

**\$4695 Standard Fabric**

**\$4975 Front Runner**

*Optional features:*

\$240 Striping on back

\$680 Marble columns (\$85 per column section)

\$815 Molded case upgrade (requires only two molded case and one round case)

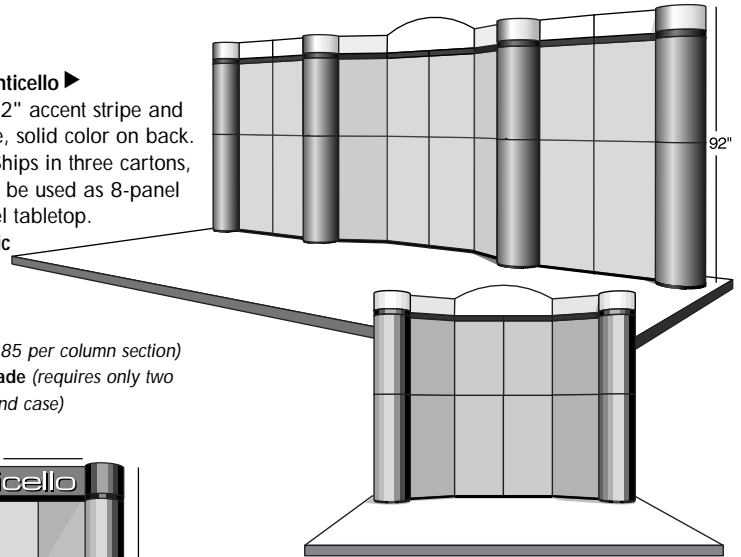

### ▲ MC•8C2-BL - 10' Monticello with 80" Backlit Header

Includes two columns, 2 bulb lightbar, 2" base accent stripe and header stripe.

**\$2885 Standard Fabric**

**\$2995 Fabric Upgrade\***

### ▲ MC•8C2-A2 - 10' Arch-Top Monticello

Includes two columns, 2" accent and header stripe on front side, solid color on back. Includes clear Lexan® header.

Ships in two cartons, 50 lbs each.

**\$2395 Standard Fabric**

**\$2555 Fabric Upgrade\***

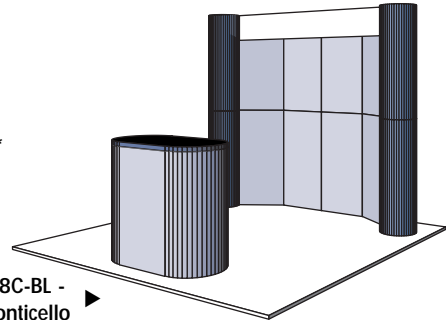

### EMC•8C-BL - 10' Monticello ▶

Includes 12"x80" backlit header. Ships in one HDSC-W molded shipping case and one 12"x50" Smartpak Graphics Case.

**\$2295**

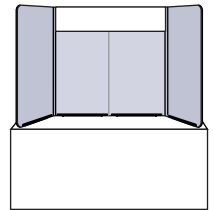

Center section, top or bottom, can be used as 4-panel tabletop

### ▲ MC•20C4-BL - 20' Monticello with Backlit Headers and Counters

Includes four columns, four 3-bulb lightbars, 2" accent stripe and header stripe front side, solid color on back. Three translucent Lexan® headers. Ships in six cartons, 50 lbs.

**\$7595 Standard Fabric**

**\$7995 Fabric Upgrade\***

### EMC•16C20' Monticello ▶

Includes eight patented rollable column sections. Features 12"x80" back-lit header with 3-bulb 100w lightbar. Ships in two HDSC-W molded shipping cases and one 16"x50" Smartpak Graphics Case. Shown with optional ECCM-40 curved counters. Counters ship in one case each.

**EMC-16C \$4995**

**ECCM-40 \$825 ea.**

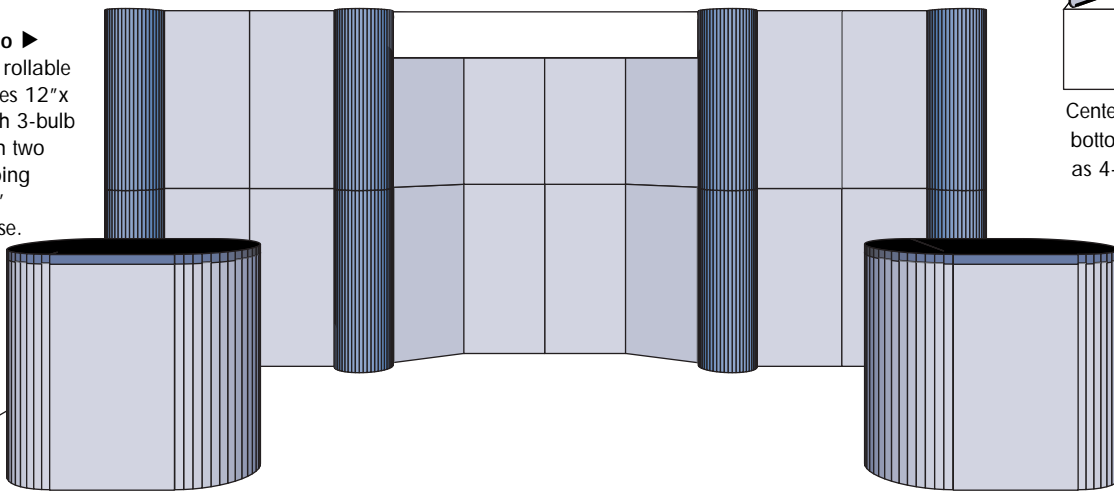

\*Standard Fabric prices include Tempo® or Showtime® Fabric. Fabric Upgrade prices listed include Front Runner® or Prelude® fabric on front side. Add \$10 per panel upgrade on back.

\*Fabric Upgrade prices listed include Front Runner® or Prelude® fabric on front side only. Add \$10 per panel upgrade on back.

## FEATURED DISPLAYS

### 6' Regency Tabletop

(Top left)

This lightweight tabletop features rollable curved end panels and a 12" x 44" backlit header and lightbar.

ERT•44T \$895  
Fabric Upgrade\* \$955

### 6' Regency Arch-Top

(Top right)

This arch-top Regency tabletop fits a 6' table. Includes inlaid fabric stripes on front side solid color on back.

ERT•44A2 \$895  
Fabric Upgrade\* \$955

### 20' Regency Freestanding with Backlit Headers

This 20' Regency is ideal for large mural graphics and features a tower and bridge headers and 12" x 92" backlit headers for added visibility. Can also be used separately as a 10' freestanding display. Packs into six cases.

RFD•20TB - 20' Regency as shown \$6995  
(with striping)  
Fabric Upgrade\* \$320  
Accent Stripes on Regency \$980  
Tower, Bridge \$1295  
Counter \$725  
Striping on Tower and Counter \$195  
Fabric Upgrade on Tower \$65

### 20' Regency Freestanding with Backlit Header

This 20' Regency is shown with recessed counter with sliding doors. Includes two 12" x 92" backlit headers with lightbars and optional counter. Can as used separately as 10' freestanding display. Ships in five corrugated shipping cases included.

RFD•20 - 20' Regency \$5395  
Fabric Upgrade\* \$380

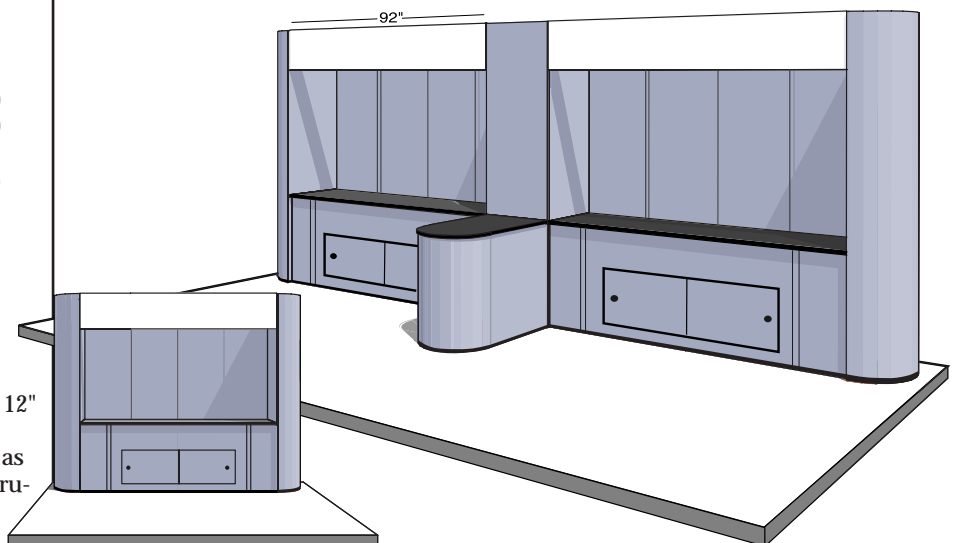
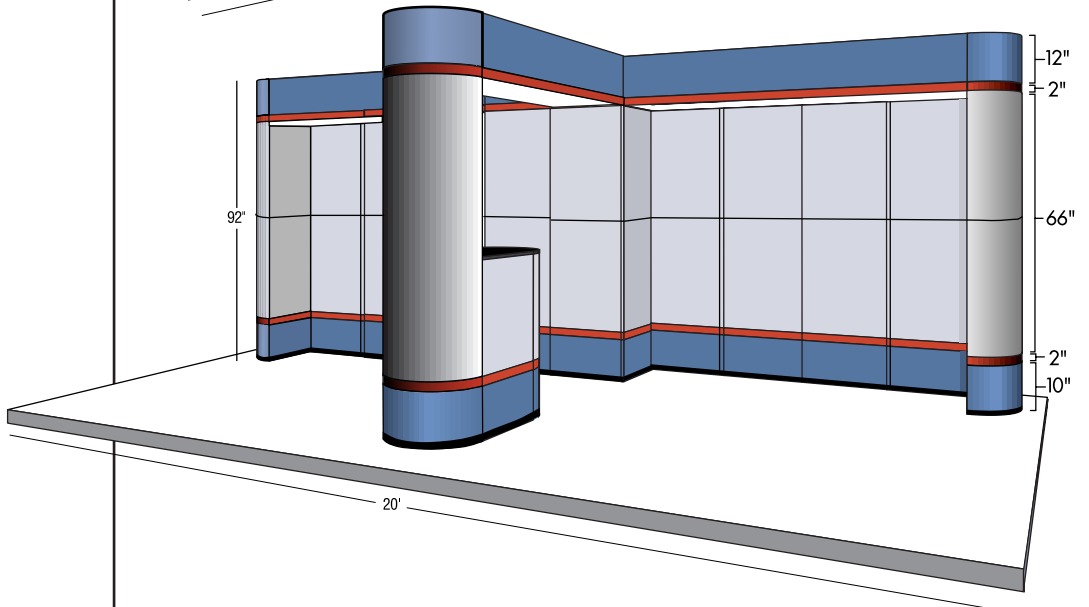
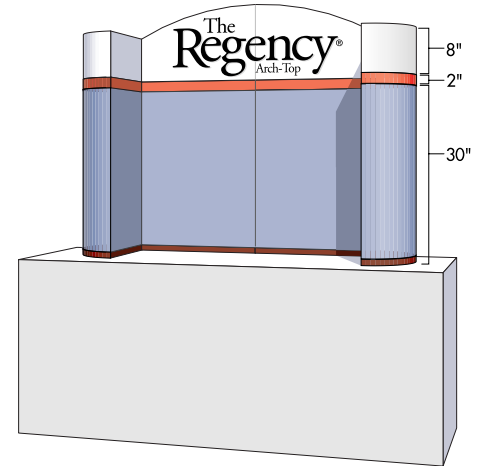

# REGENCY® DISPLAYS

\*Standard Fabric prices include Tempo® or Showtime® Fabric. Fabric Upgrade prices listed include Front Runner® or Prelude® fabric on front side. Add \$10 per panel upgrade on back.

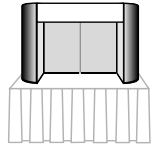

**ERT•44**  
**2-Panel Tabletop**  
 44" backwall, 12" x 44" backlit header and lightbar, one carton, 35 lbs.  
**\$895 Standard Fabric**  
**\$955 Fabric Upgrade\***

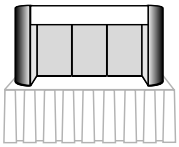

**ERT•66**  
**3-Panel Tabletop**  
 66" backwall, 12" x 69" backlit header and light bar, one carton, 40 lbs.  
**\$935 Standard Fabric**  
**\$995 Fabric Upgrade\***

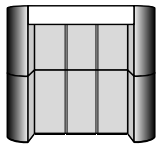

**ERF•6**  
**6-Panel Freestanding**  
 12" x 69" backlit header, light bar, two cartons, 45 lbs.  
**\$2270 Standard Fabric**  
**\$2410 Fabric Upgrade\***

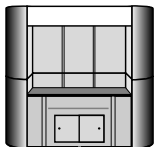

**ERF•6RC**  
**6-Panel Counter**  
 12" x 69" backlit header, light bar, 20" x 69" counter, three cartons, 45 lbs. each.  
**\$2795 Standard Fabric**  
**\$2935 Fabric Upgrade\***

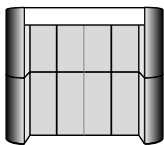

**ERF•8**  
**8-Panel Freestanding**  
 12" x 92" backlit header, two light bars, two cartons, 50 lbs. each.  
**\$2695 Standard Fabric**  
**\$2875 Fabric Upgrade\***

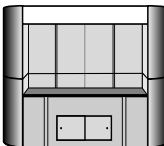

**ERF•8RC**  
**8-Panel Counter**  
 12" x 92" backlit header, 40" tall counter, two light bars, three cartons, 50 lbs. each.  
**\$3290 Standard Fabric**  
**\$3495 Fabric Upgrade\***

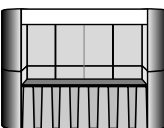

**ERF•8SK**  
**8-Panel Table with Skirt**  
 12" x 92" backlit header, two light bars, three cartons, 50 lbs. each.  
**\$2995 Standard Fabric**  
**\$3175 Fabric Upgrade\***

## ABOUT THE REGENCY®

- All Regency displays include our lightweight rollable end caps.
- Backlit headers with lightbars are included as shown.
- Custom marble laminate is available for *Regency Curve Panels*. For *Marble End Caps on Regency Tabletops*, add \$50 and on *Regency Freestanding*, add \$85 per column section
- For fabric upgrade on curved endcaps add \$15 per section

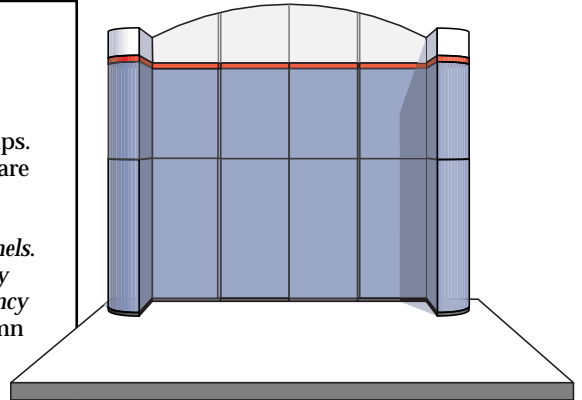

**ERF•8A4 - Regency 10' Arch-Top Freestanding Display (Above right)**  
 Shown with arch-top header with inlaid fabric stripes. Ships in three cartons, 50 lbs. each.  
 Fits in 10' booth.

**\$2745 Standard Fabric**  
**\$2925 Fabric Upgrade\***

**ERF•6A3C - Regency 8' Arch-Top Freestanding Display with Recessed Counter.**  
 Shown with arch-top header with inlaid fabric stripes and 40" high counter with sliding doors. Ships in three cartons, 50 lbs. each.

**\$2895 Standard Fabric**  
**\$3095 Fabric Upgrade\***

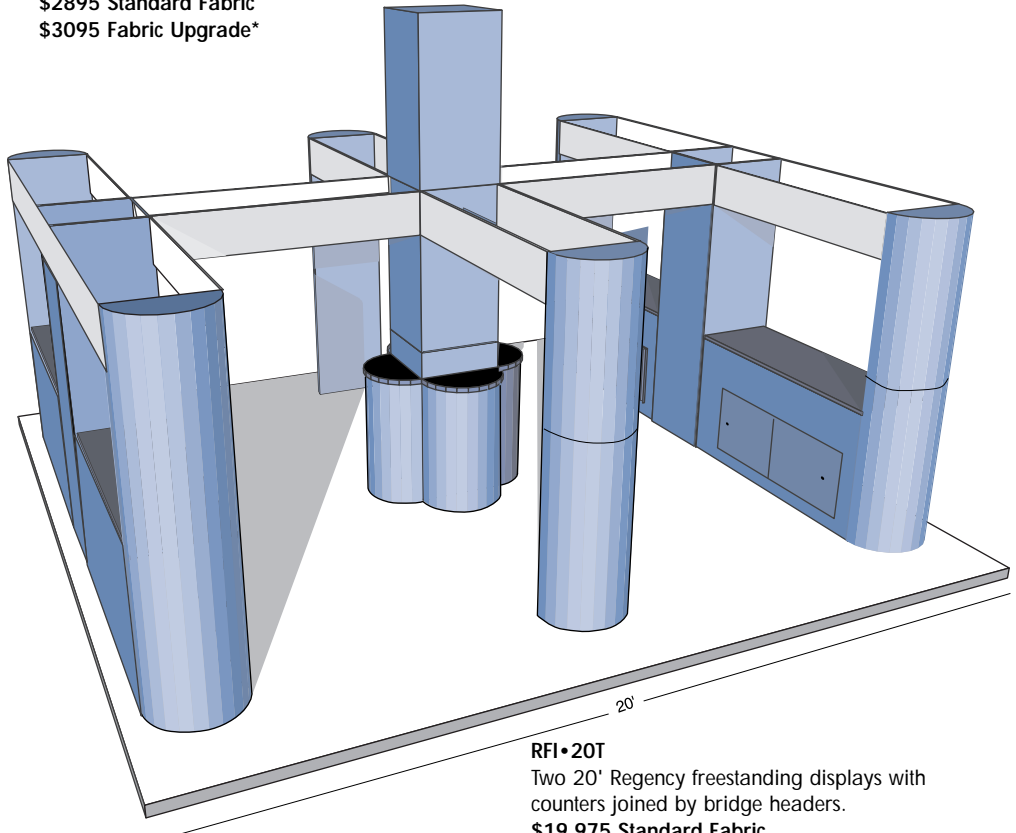
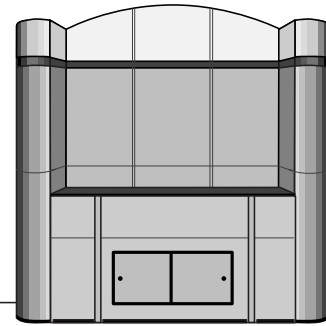

**RFI•20T**  
 Two 20' Regency freestanding displays with counters joined by bridge headers.  
**\$19,975 Standard Fabric**  
**\$20,895 Fabric Upgrade**

# CUSTOM DISPLAYS

## 20' x 20' Monticello Island with Tower & Bridge Headers

This island configuration is loaded with attention getting features. Striking design elements include a backlit tower, Wrap-Surround backlit bridge and column graphics. Includes 8 patented rollable columns, packs into 5 Smartpak cases and 6 molded cases.

MC•20/20-BL \$19,795  
 Unit Includes:  
 2 ECCM-40 Counters  
 Striping and Fabric Upgrades  
 WrapSurround Backlit Headers  
 8-14" x 84" Headers With Soffits  
 4-24" x 36" Backlit Posters on Columns  
 4-22" x 36" Backlit Tower Headers  
 4-16" x 36" Backlit Column Sections

Backlit Header and Column Graphics \$9,500  
 Case Upgrade \$1,125  
 5-16" x 50" Molded Smartpak \$1,770  
 6-HDSC-W Molded Cases \$1,770

### FEATURED DISPLAY

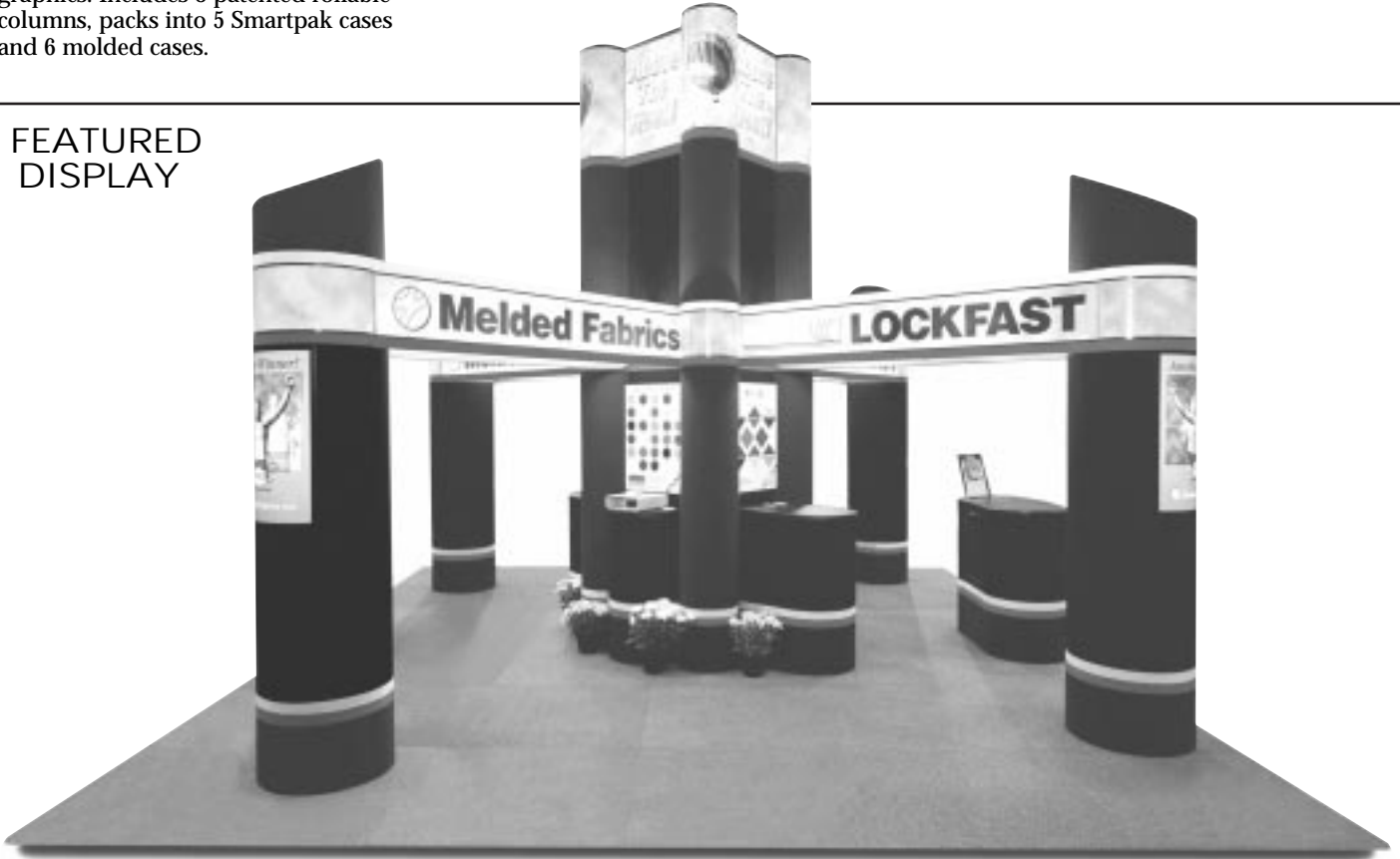

## 20' x 20' Island with Tower & Bridge Headers

This island configuration features four square towers with backlit "V" bridge headers attached to the 12' tall center towers. Lightboxes can be added to towers to highlight graphics. Ships in twelve cartons.

Tower and Bridges \$13,570  
 Counters (\$795 each) \$3,180  
 Total price as shown \$16,750

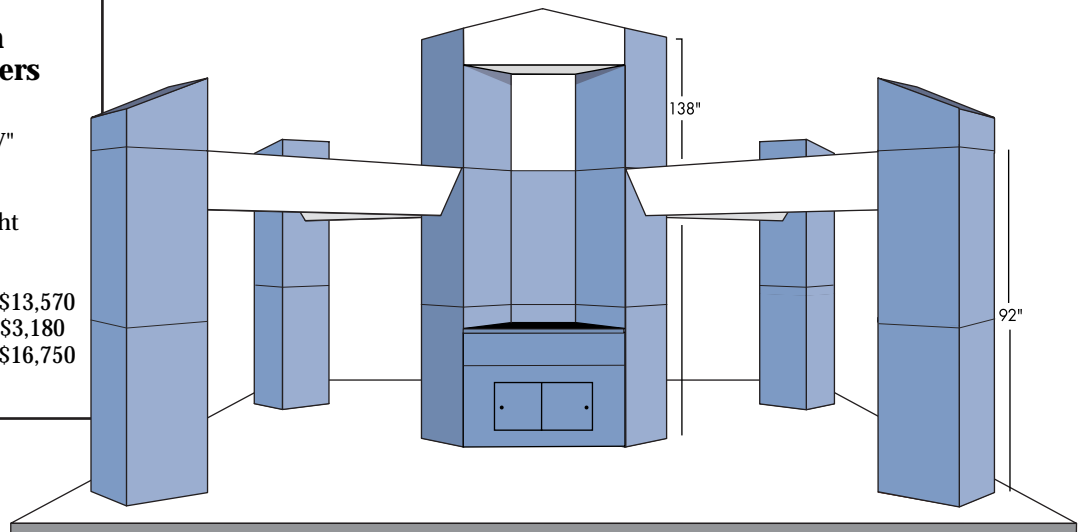

FEATURED DISPLAYS

**20' x 20' Tower & Bridge with Curved Towers**

This 20' x 20' configuration uses curved columns to create four tower and bridge headers attached to 12' high center tower. Bridge headers are backlit with two 3-bulb-lightbars with 100w halogen bulbs. Shown with four 40" high curved counters and curved podiums attached to tower. Ships in eight shipping cartons. Also shown is curved step counter with 40" high center section with 2'x2' top and 30" high curved side panels.

ETB•4-92	
Tower & bridge assembly	\$7515
Curved counters (\$695 each)	\$2900
Curved podiums (\$395 each)	\$1580
Total Kit price as shown	\$11,535
Total Fabric Upgrade	\$11,955
Optional Curved Counter	\$925

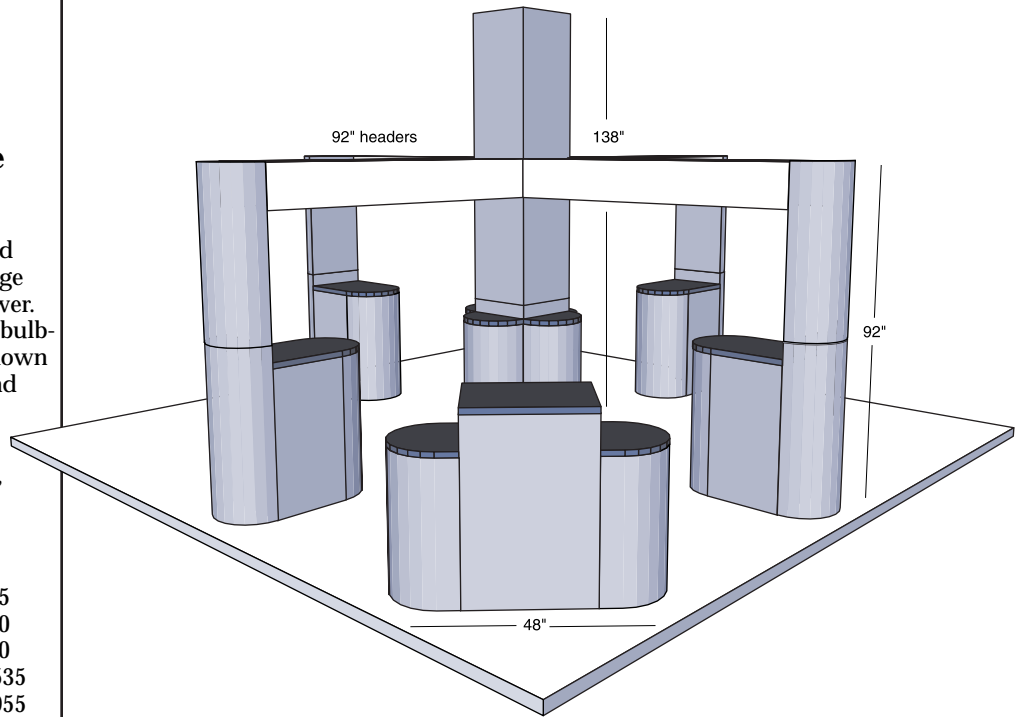

**20' Independence with Tower & Bridge**

Features patented ExpoStar square columns and angled side counters. Backlit headers are 12" x 92" with 22" wide center tower. Opening can be added to tower for AV monitor or backlit graphic. Ships in five cartons.

Total price as shown	\$8,325
Fabric Upgrade* front side	\$8,595

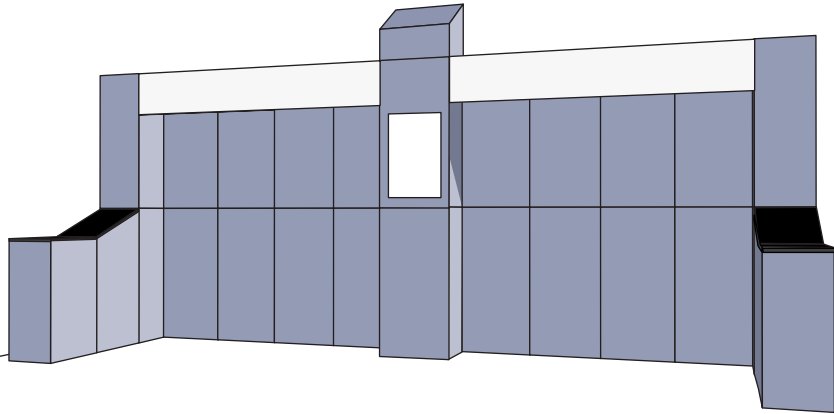

**20' Independence with Gabled Header**

Adding these 44" tall counters on each side of this 20' backwall creates an wrap-around 20' in-line booth. Features our new gabled back-lit header. Pictured with optional accent stripes on base. Ships in five cases.

Total price as shown	\$7795
Fabric Upgrade	\$8415
Stripes on back add	\$480
Without counters	\$5805

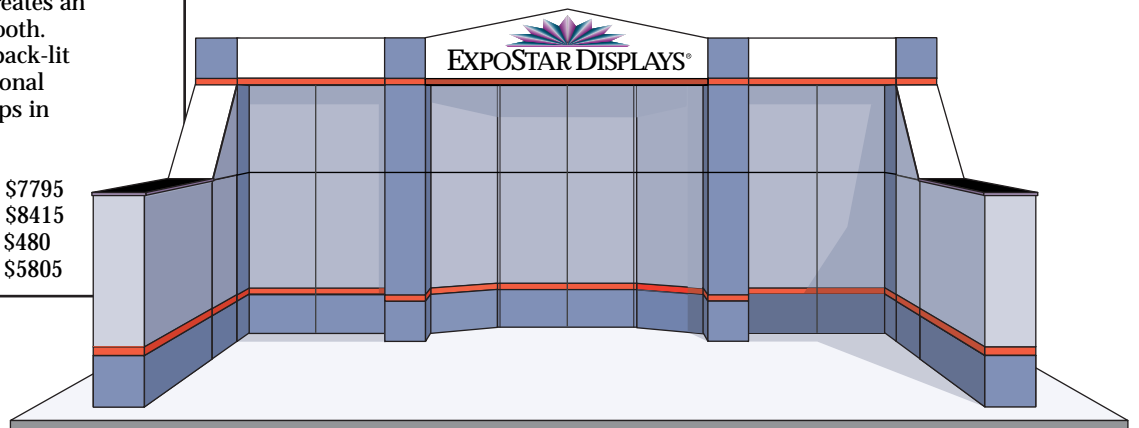

## ABOUT THE RENAISSANCE

- The Renaissance is one of our newest innovations in display design. The lightweight rollable end columns utilize our patent-pending hub design.
- Available for 6' or 8' table with two or three panel solid backwall.
- Solid wall back panels are covered on both sides with Velcro compatible fabric.

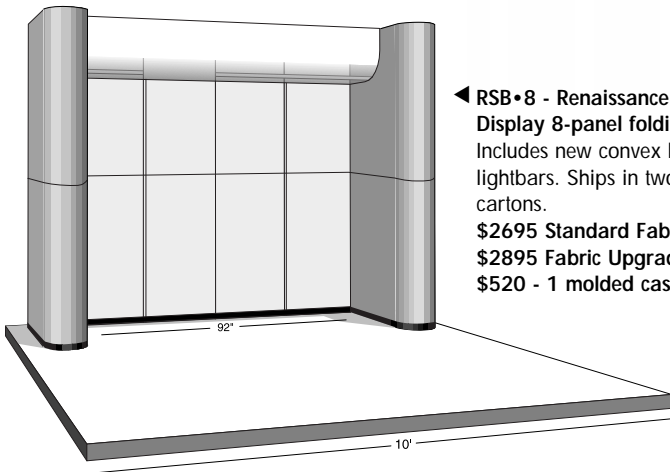

- ◀ **RSB•8 - Renaissance 10' Freestanding Display 8-panel folding backwall.**  
Includes new convex backlit header and 2 lightbars. Ships in two shipping cartons.  
**\$2695 Standard Fabric**  
**\$2895 Fabric Upgrade\***  
**\$520 - 1 molded case, 1 column case**



- RSB•14 - Renaissance 20' Display**  
Includes new convex backlit headers and 4 lightbars. Ships in four shipping cartons.  
**\$4995 Standard Fabric**  
**\$5395 Fabric Upgrade\***  
**\$1040 - 2 molded cases, 2 column cases**

- RSB•44T - Renaissance Tabletop with 2-panel folding backwall.** ▶  
One lightbar included.  
Ships in standard 24"x 45" shipping carton.  
**\$895 Standard Fabric**  
**\$955 Fabric Upgrade**

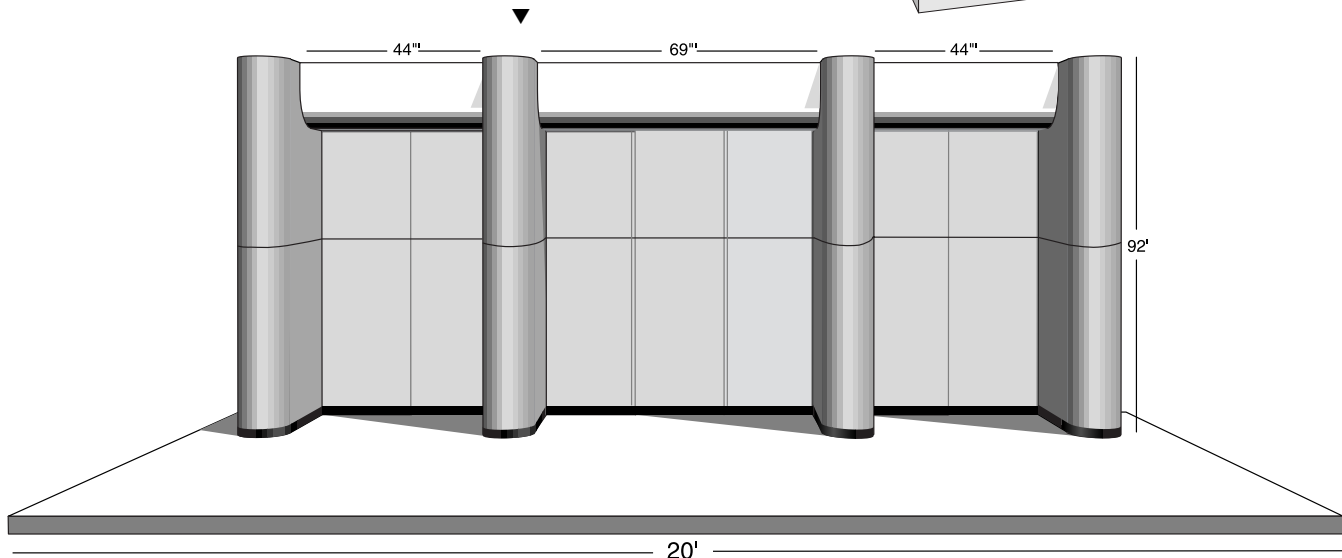



## SHOWSTYLE® BRIEFCASE PRESENTATION SYSTEM

The first high performance briefcase.  
Goes from 0 to set-up in less than 15 seconds.



### ABOUT SHOWSTYLE

- Brings compact style to any presentation.
- Lightweight polyethylene panels unfold to create a generous 48" x 24" display.
- Create your own high impact visuals! Attach adhesive Velcro dots to the back of photos, charts, signs or other elements and simply press onto the velcro ready fabric display area.
- When presentation is finished, simply fold up ShowStyle with visuals still attached. Make every presentation an open and shut case with ShowStyle!

## ShowStyle™

Briefcase Presentation System

showstyle@prezenta.com  
www.prezenta.com

SS-1224 ShowStyle Briefcase Presentation System

Price includes choice of black, blue, silver or burgundy fabric.

\$295

Call for graphics pricing information



## MAGICPAK® RETRACTABLE BANNER DISPLAYS

From carrying case to freestanding display...in less than 60 seconds!

### ABOUT MAGICPAK

- The Magicpak Retractable Banner Display System incorporates a precision tension roller that enables anyone to produce astounding professional quality visuals with "the greatest of ease".
- The 10 lb. display unit will instantly produce a 33.5" x 80" graphic that retracts after the presentation.
- Magicpak's graphics are transported, stored and safely rolled, inside the ultimate protective shell.
- Graphics are interchangeable and installed by attaching to the internal film leader.
- With Magicpak, you'll be creating display magic for your company before you can say Abracadabra!



## Magicpak™

Retractable Banner Displays

Prezenta product group

magicpak@prezenta.com  
www.prezenta.com



MP•33 Magicpak Retractable Banner Display

Price includes padded nylon carry case, does not include graphics.

\$595

Call for graphics pricing information



Combine multiple Magicpak Displays to create any size backwall display. This configuration would fit a 10' space.

Manufactured in Stockholm Sweden by Expand International, AB

# PODIUMS, COUNTERS

## ABOUT PODIUMS

■ All Podiums, including Tables, Desks and Pedestals, fold flat and ship in one carton (shipping carton included in kit price).

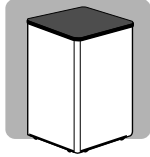

**EPS•40**  
3-Panel Podium - 40"  
2' x 2' counter top,  
25 lbs. **\$495**

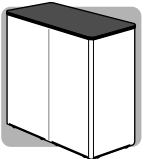

**ED4•30**  
4-Panel Desk - 30"  
2' x 4' top, 42 lbs. **\$715**  
**EC4•40**  
4-Panel Counter - 40"  
2' x 4' top, 45 lbs. **\$735**

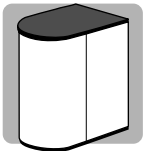

**EPC•30**  
Peninsula Counter - 30"  
2' x 3' top, 40 lbs. **\$695**  
**EPC•40**  
Peninsula Counter - 40"  
2' x 3' top, 44 lbs. **\$725**

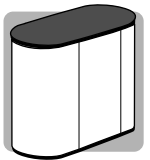

**ECDM•30**  
Curved Desk - 30"  
2' x 4' top, front panel,  
shelf. 40 lbs. **\$795**  
**ECCM•40**  
Curved Counter - 40"  
40" high with 2' x 4' top,  
45 lbs. **\$825**

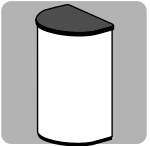

**ECP•40**  
Curved Podium - 40"  
16" x 24" tabletop,  
28 lbs. **\$395**

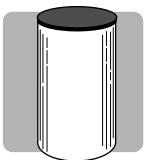

**RPB•30**  
**RPB•40**  
Circular Pedestal  
24" diameter top, 30 lbs.  
30" high **\$375**  
40" high **\$395**

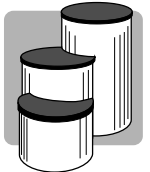

**RBSP•3**  
Circular Step Pedestals  
24" diameter tops,  
40", 30" & 20", 55 lbs.  
**\$895**

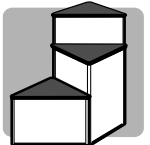

**TSP•3**  
Triangular Step Tables  
40", 30" & 20" high,  
55 lbs. **\$975**

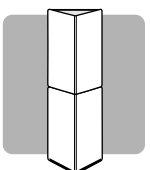

**TST•6**  
Triangle Tower  
Two 3-panel stacking  
units, 88" high, 38 lbs.  
Use as two 3-panel  
tabletop displays.  
**\$830**

## DOOR ASSEMBLIES

Optional door panels for use with tables, counters and podiums. Keylocks for doors are available at \$25 each.

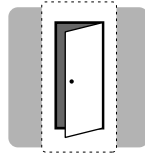

**HD•16/24**  
Hinged Door (door only)  
16" x 24" door. Maximum  
size 18" x 36". Fits curved  
podiums, or add to any  
desk or counter panel.  
**\$95**

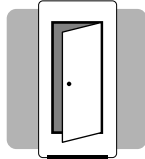

**HDA•22/40**  
Single Panel Door Assem-  
bly  
16" x 24" door fits Curved  
Counter or 3-Panel Podium.  
**HDA•22/30** fits 30"  
Curved Desk. 8 lbs.  
**\$225**

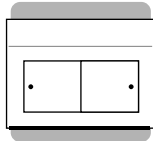

**SDA•30/44**  
4-Panel Desk Door  
16" x 36" sliding door fits  
4-Panel Desk, 30" high.  
12 lbs.  
**\$275**

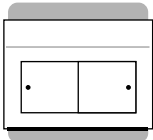

**CSD•40/44**  
4-Panel Counter Door  
16" x 36" sliding door fits  
4-Panel Counter, 40" high.  
15 lbs.  
**\$295**

## RECESSED COUNTERS

Fits freestanding units to provide counter and cabinet space for display and storage.

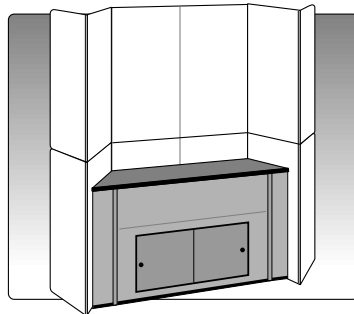

**RCA•60/30**  
Recessed Counter 30"H  
60" x 18" laminated hinged top and sliding  
door. Folds flat for shipping. Fits 8 and 12-  
panel freestanding displays.  
44 lbs.  
**\$495**

**RCA•60/40**  
Recessed Counter 40"H  
Taller version of above counter. 48 lbs.  
**\$555**

*Note: Custom size counters also available.*

# HEADERS

## ABOUT HEADERS

- Backlit Headers  
Rollable, one-piece translucent  
Lexan® attached to aluminum  
frames with magnetic strips.
- Palladian Arch Headers  
Clear Lexan® attached with Velcro.
- Radius Headers  
White Sintra® with radius corners  
attached with Velcro.
- Continuous Wrap Headers  
Flexible Lexan® or vinyl attached  
with Velcro.®

### Backlit Headers

**BLH•12/44** 12" x 44" Backlit Header  
Fits RSS•3T, 5T, 10F. 2 lbs. **\$95**

**BLH•12/60** 12" x 60" Backlit Header  
Fits RSS•4T, 6T, 8F, 12F. 3 lbs. **\$135**

**BLH•12/69** 12" x 69" Backlit Header  
Fits ERF•6, 6TK. 3 lbs. **\$145**

**BLH•12/80**  
12" x 80" Backlit Header  
Fits RSS•10C. 3 lbs. **\$175**

**BLH•12/92**  
12" x 92" Backlit Header  
Fits ERF•8, 8TK, 8SK. 4 lbs. **\$195**

*Lightbar not included with backlit headers.*



### Palladian Arch Headers

**PH•12/22**  
12" x 22" Single Arch Header  
1.5 lbs. **\$25**

**PH•14/44**  
14" x 44" Double Arch  
Header 2 lbs. **\$35**

**PH•14/69**  
14" x 69" Rollable Triple Arch Header  
1 lb. (.020 clear Lexan film) **\$45**

**PH•10/18** Mini Single Arch Header  
10" x 18" 1.5 lbs. **\$20**

**PH•12/36** Mini Double Arch Header  
12" x 36" 2 lbs. **\$30**



### Radius Headers

**RH•10/22**  
10" x 20" Radius Header  
2 lbs. **\$25**

**RH•10/44**  
10" x 44" Radius Header  
4 lbs. **\$35**

**RH•8/18**  
8" x 18" Mini Radius Header 1.5 lbs. **\$20**

**RH•8/36**  
8" x 36" Mini Radius Header 2 lbs. **\$30**



### Continuous Wrap Headers

**CH•12/180V**  
12" x 180" Continuous  
Vinyl Header  
White vinyl or Lexan header  
with Velcro  
2 lbs. **\$75**



## CUSTOMIZED COMPONENTS

The following components coupled with our basic display panels maximize visual impact and create a more expansive custom look.

### TOWER & BRIDGE

**ETB-84BLH**

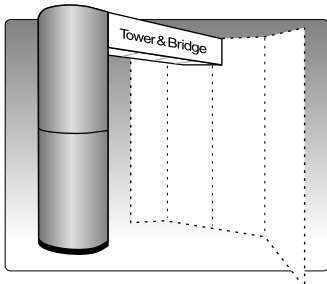

Backlit bridge header attaches to tower to create double-sided lighted header for corporate identity. Tower may also be used separately as two 46" podiums by adding curved podium tops. Includes two light bars. One carton, 55 lbs.  
**\$1295**

### SOFFIT PANELS

Translucent Lexan® soffit panels are available for all backlit headers. Simply unroll, attach to the header with magnets and to the display with Velcro® to provide a diffuser for the light bar.  
**\$1 per inch length of header**

### LIGHT BOXES

**CLB•16/30**

**Collapsible Light Box**  
 Includes framed cutout (18" x 30" max), 3-bulb light bar.  
**\$250**

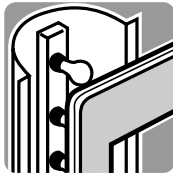

### PANEL WINDOW

**PCO•16/30 Panel Window**

Panel openings can be custom cut for video monitors, recessed shelving, etc. or any specifications no larger than 18" x 30".  
**\$75**

### CURVE PANELS

Customize your display by adding ExpoStar's unique 360° curved end caps or columns. Simply roll and lock into place for each assembly. Order right and left pair for tabletop, and two pair (right and left) for freestanding displays. Patent pending.

**CP•44 Curved End Cap**

44"H, lays flat for shipping **\$95 each\***  
 \*Add \$15 per seam for striping, \$15 for fabric upgrade and \$35 for marble laminate.

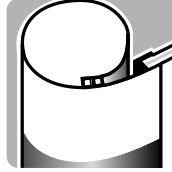

**EMC•46 Rollable One-Piece Columns**

15" diameter 360° column to use as endcaps See Monticello pages 10-11  
**\$195 each\***  
 \*Add \$25 per seam for striping, \$20 for fabric upgrade and \$85 for marble laminate

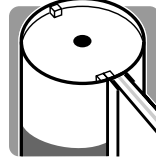

**ESC•46 Square One-Piece Columns**

12" column **\$225 each\***  
 \*Add \$25 per seam for striping  
 \*Add \$20 fabric upgrade charge for Front Runner® or Prelude® fabrics.  
 \$85 for marble laminate

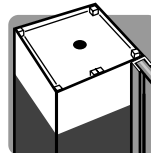

**ERC•46 Renaissance Column**  
**\$250 each**

\*Add \$25 per seam for striping, \$20 for fabric upgrade and \$85 for marble laminate

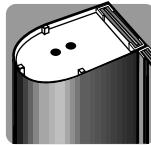

**ERS•46 Regency Column**  
**\$265 each**

\*Add \$25 per seam for striping, \$20 for fabric upgrade and \$85 for marble laminate

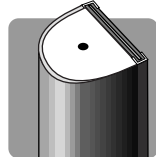

## LITERATURE HOLDERS

**FLH•5**

**5" Flat Folding Holder**  
 4 oz. **\$13**

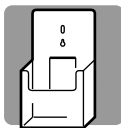

**FLH•9**

**9" Flat Folding Holder**  
 11 oz. **\$18**

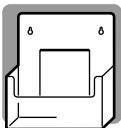

**ABH•4**

**Business Card Holder**  
**\$5**

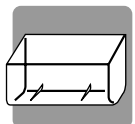

**PPS•20**

**6" X 20" Product Shelf**  
 flat folding, 2 lbs. **\$45**

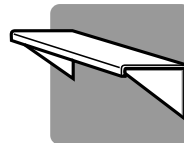

**PPS•40**

**6" X 40" Product Shelf**  
 flat folding, 4 lbs. **\$75**

**PLS•20**

**Plastic Literature Shelf**  
 11.5" x 20", 2 lbs. **\$45**

**PLS•40**

**Plastic Literature Shelf**  
 11.5" x 40", 4 lbs. **\$75**

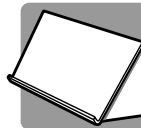

## LIGHTS

Fixture prices include bulb(s) and 14' three-wire cordset.

**WW•300**

**300W Wall Washer**  
 10" arm with slip-on base  
 2 lbs. **\$145**



**WW•200**

**200W Wall Washer**  
 10" arm with slip-on base  
 2lbs. **\$135**

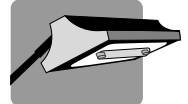

**HL•75**

**Wire Form Halogen Fixture**  
 75w par 16 halogen bulb,  
 10" arm with slip-on base  
 2 lbs. **\$99**



**SL•75F**

**Step Shade Spotlight Fixture**  
 75w R20 reflector lamp,  
 with slip-on base, 2 lbs. **\$85**



**BLB•100**

**3-Bulb Light Bar**  
 100w halogen bulbs., 2 lbs.  
**\$95**

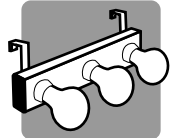

**DLB•75**

**Double Bulb Backlight Fixture**  
 5" arm with  
 100w halogen bulb,  
 1.5 lbs.  
**\$75**



**HSL•35**

**Halogen Lightbar**  
 Lightweight halogen lightbar  
 with 3 - 35w recessed bulbs..  
 1 lb.  
**\$75**

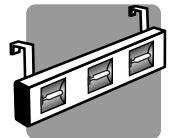

**OS•6**

**6-Way Outlet Strip**  
 switched and fused, 2 lbs.  
**\$25**

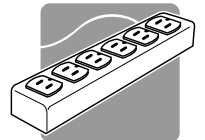

Replacement Bulbs

**LB•75H - 75w par 16 Halogen Bulb**  
**\$21**

**LB•100 - 100w Slimline Bulb**  
**\$3.50**

**HLB-100 100w Halogen Bulb**  
**\$12.00**

**RHB•35 - 35w bulb for HSL•35 lightbar**  
**\$7.50**

**Bulbs. for WW•300**  
 200w halogen bulb **\$15**  
 300w halogen bulb **\$15**

## PANEL ACCESSORIES

Velcro® Hook Tape  
Pressure-sensitive tape or dots (50 dots per yard)

**HD•3 - 5/8" Hook Dots**  
\$3.75 per yard

**HT•3 - 5/8" Hook Tape**  
\$3.75 per yard

Foot Channel  
**FC•22 - With bumper**  
\$5 each

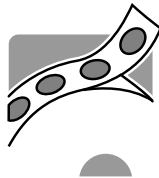

Stacking Guides  
**SG•18**  
\$2.50 each

### ABOUT JOINER STRIPS

- Fabric-covered joiner strips allow panels to be joined in a variety of ways.
- Two joiner strips are required for freestanding displays.

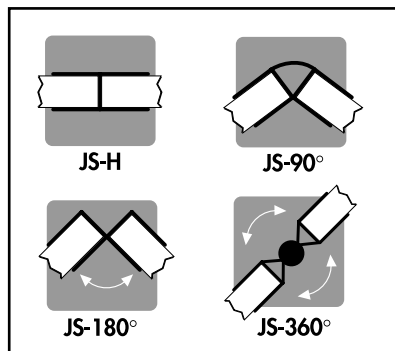

Joiner Strips

**JS•H** \$35  
**JS•90°** \$35  
**JS•180°** \$45  
**JS•360°** \$50

Wire Grommets

For use in wiring display panels and /or counter tops. 2" in diameter.  
\$25 each

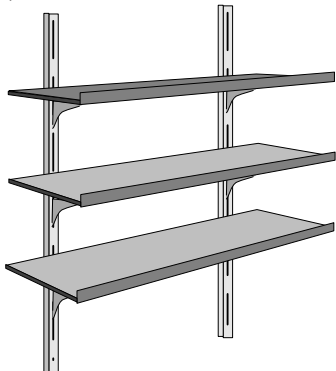

Shelves with Standards

Shelves with standards can be attached to most panels. Available with 6", 8" and 10" shelves.  
\$195 per section with three shelves.

20

## COUNTERTOPS

### ABOUT TABLETOPS

- Counters or tabletops can be ordered separately to be used with existing panels.
- Tabletops are black laminate with rubber-edge banding for durability.
- For custom colors, add 25%.

**LPT•22**  
**3-Panel Podium Top**  
Fits EPS•40 Podium, 7 lbs. \$95

**LD•24**  
**4-Panel Desk/Counter Top**  
Fits ED4•30 Counter, EC4•40 Desk, 14 lbs. \$175

**LCP•24**  
**Curved Podium Top**  
18" x 24" curved top, fits ECP•40, 10 lbs. \$95

**LCD•24**  
**Curved Desk/Counter Top**  
Fits ECD•30 and ECC•40, 14 lbs. \$175

**LRC•60**  
**18" x 60" Two-Piece Recessed Top**  
For use with recessed counter, 14 lbs. \$185

**RPS•22**  
**2' x 2' Recessed Podium Shelf**  
Fits inside 3-panel podium, curved desk or counter, 14 lbs. \$85

**RPS•24**  
**2' x 4' Recessed Counter Shelf**  
Fits inside 4-panel counters and desks, 14 lbs. \$125

## SLATWALL

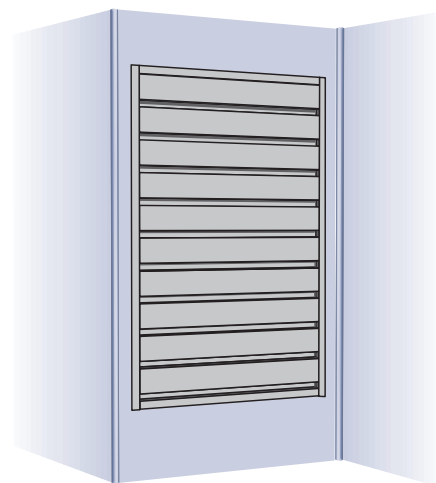

**SWP• 18/30 SlatWall Panels**  
Fabric covered slatwall panels can be recessed into display panels up to 18" wide x 30" high.  
\$175

## TABLE ACCESSORIES

### ABOUT TABLE SKIRTS

- Available in a wide range of colors and fabrics, all skirts include Velcro® top banding.
- Skirts can be custom imprinted with your company name or logo
- 14' table skirts wrap all sides of 6' table and 3 sides of 8' table
- 21' table skirts wrap all sides of 8' table.

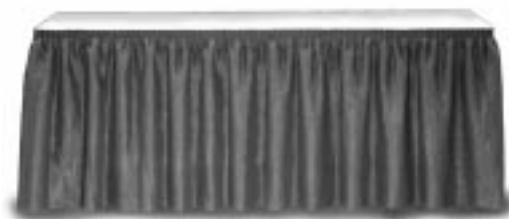

Banjo Skirt  
**SBJ•14 - 29" X 14' Skirt**  
\$105

**SBJ•21 - 29" X 21' Skirt**  
\$180

PolyKnit Skirt  
**SBK•14 - 29" X 14' Skirt**  
\$60

**SBK•21 - 29" X 21' Skirt** \$90

PolySateen® Skirt  
**SBS•14 - 29" X 14' Skirt** \$50

**SBS•21 - 29" X 21' Skirt** \$90

PolyTwill® Skirt  
*PolyTwill is Shirred, includes table clips*

**SPT•14 - 29" X 14' Skirt** \$162

**SPT•21 - 29" X 21' Skirt** \$200

PolyTwill® Table Throw Covers  
**SPC•6** One-piece cover fits 6' table \$125

**SPC•8** One-piece cover fits 8' table \$145

Vinyl Table Covering  
**VTC•30**  
30" wide, various colors \$1.45 per yard

Table Skirt Clips  
**TCV•3**  
Fits all table styles \$2.50 each

Skirt Hangers  
**HSK•1**  
Helps keep skirts wrinkle-free \$8.50 each

## FABRICS

ST•63 Showtime® Fabric (no upcharge)

PR•55 Prelude® Fabric  
\$10 per panel per side

FR•55 Front Runner® Fabric  
\$10 per panel per side

Cut Yardage

TF•60 Tempo® Fabric 60" wide \$21 per yard  
(Standard Fabric)

FR•55 Front Runner® 63" wide \$27 per yard

ST•63 Showtime® 63" wide \$25 per yard

PR•55 Prelude Fabric 63" wide \$27 per yard

## CUSTOM HEADERS

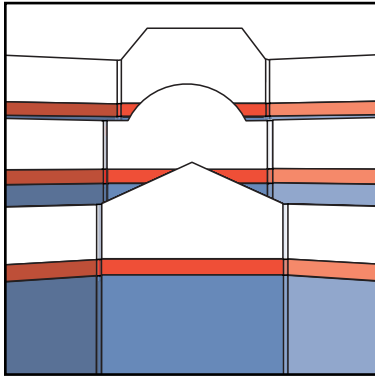

Display panels can be custom-cut to a variety of shapes and sizes to match your company logo or image. For custom-cut headers add \$75.

## ABOUT CUSTOM STRIPING

- Custom striping adds bold graphic lines or a subtle design element to your display.
- To calculate cost for adding stripes, simply count the number of fabric stripes (or seams) and the number of panels and/or curves to be striped. Use the chart below for assistance.
- For Curved Podium, Curved Desk or Curved Tower add \$25 per stripe per seam. For Monticello columns add \$25 per seam.

NUMBER OF SEAMS OR STRIPES

PANELS WITH STRIPES

	1	2	3	4	5	6	7	8
1	\$15	\$30	\$45	\$60	\$75	\$90	\$105	\$120
2	\$30	\$60	\$90	\$120	\$150	\$180	\$210	\$240
3	\$45	\$90	\$135	\$180	\$225	\$270	\$315	\$360
4	\$60	\$120	\$180	\$240	\$300	\$360	\$420	\$480
5	\$75	\$150	\$225	\$300	\$375	\$450	\$525	\$600

## SHIPPING CASES

Heavy-Duty Molded Shipping Cases

HDSC•W Large Case with wheels  
24" x 50" x 6"\*\*, 22 lbs.\* \$295

HDSC•W42 Small Case with wheels  
24" x 42" x 7"\*\*, 18 lbs.\* \$245

Smaller case ideal for podiums or small tabletop kits less than 40" tall. (black only).

\*Adds 12 lbs. to kit weight per case.

Cordura® Shipping Cases

CSC•44



HDSC•W



CSC•44 - Cordura® Nylon Case

Gray with blue shoulder straps, handwrap. Holds full-size tabletop displays. \$185

CSC•36 Cordura® Nylon Case

This smaller case is perfect for sales reps for easy carrying. For mini-sized tabletop displays. Size 20" x 36" x 4" (see pages 7 & 9) \$150

Smartpak™ Molded Shipping Cases

SPC•12/26 Molded Case  
12" x 26" \$115

SPC•12/38 Molded Case  
12" x 38" \$150

SPC•12/50 Molded Case  
12" x 50" \$175

SPC•12/62 Molded Case  
12" x 62" \$200

SPC•12/72 Molded Case  
12" x 72" \$250

SPC•16/42 Molded Case  
16" x 42" \$200

SPC•16/50 Molded Case  
16" x 50" Shipping case for Monticello columns.  
Holds 8 column sections and hubs. \$225

EUC•24/12

Utility Case  
Roto Molded plastic case Ideal for shipping literature and accessories.  
24" x 12" x 8" \$150

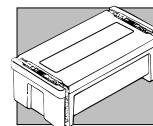

Smartpak™  
The Best Insurance  
You Can Carry.



# TYPES OF GRAPHICS

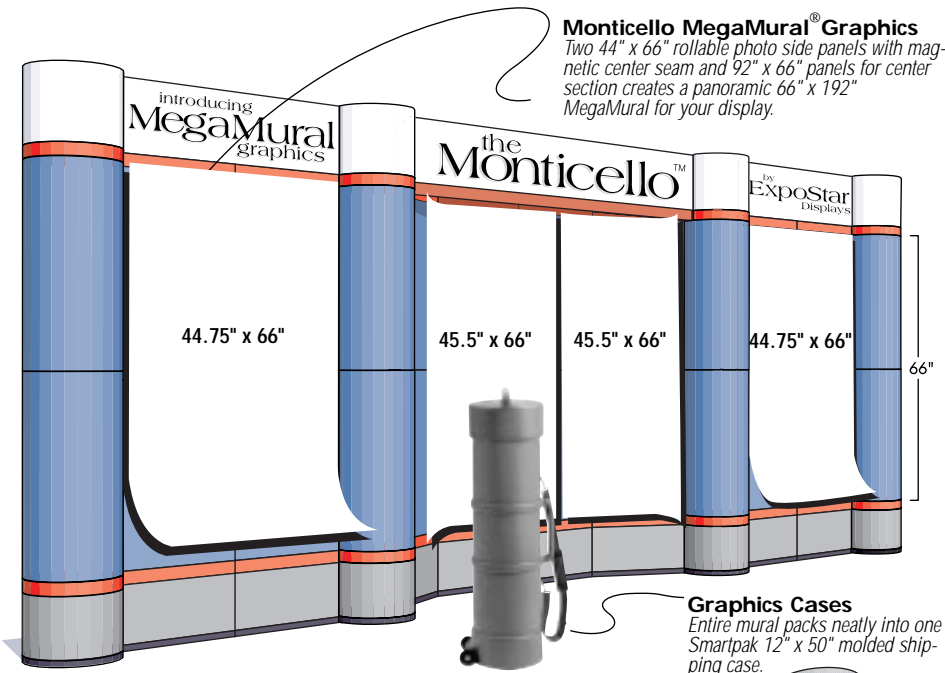

## MEGAMURAL™ GRAPHICS

With this incredible computer process, any combination of photographs, backgrounds, logos and text can be combined, retouched, enhanced and printed in mural sizes. Transform your display walls into show stopping vistas with ExpoStar MegaMural graphics.

## PHOTO PANELS

Large photos make dynamic display signage. Photos can be reproduced directly from your transparencies or enhanced through color correction and retouching. Captions can be applied directly to photo or added with separate text strip signs.

## EXPOGRAPHICS

From charts and graphs to location maps, there is no limit to the informative and eye-catching original color graphics that ExpoStar can create. Let us design excitement and interest into your next presentation.

## HEADERS

The center or main sign on a display, often incorporating a company logo or name, is very important to your display's impact. A wide range of brilliant colors and backgrounds are available. Photos and other graphics can also be incorporated into the header.

## BACKLIT SIGNAGE

Most signage and photo panels can be prepared on translucent backgrounds for use with lightboxes. Backlit headers, available for many displays, add a bright new dimension to your message.

## TEXT STRIPS & PANELS

Signs with brief text can be created in a variety of ways- from single color text on clear plastic, to a rainbow assortment of colors and background textures.

## VINYL SIGNS

Durable, economical, vibrant. Vinyl signage adds an attractive accent to any graphics package.

## Pop-up Graphics

The Standard Size for each Starlite™ pop-up panel is 26.5" X 88". ExpoStar also produces graphics for all other sizes of Pop-up display units. Pop-up displays may be full graphic as shown at right, or with fabric panels and a continuous header as shown below.

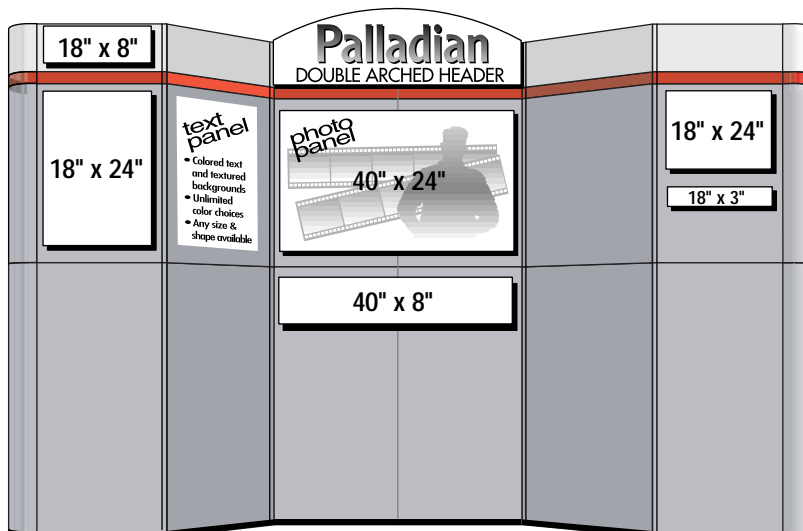
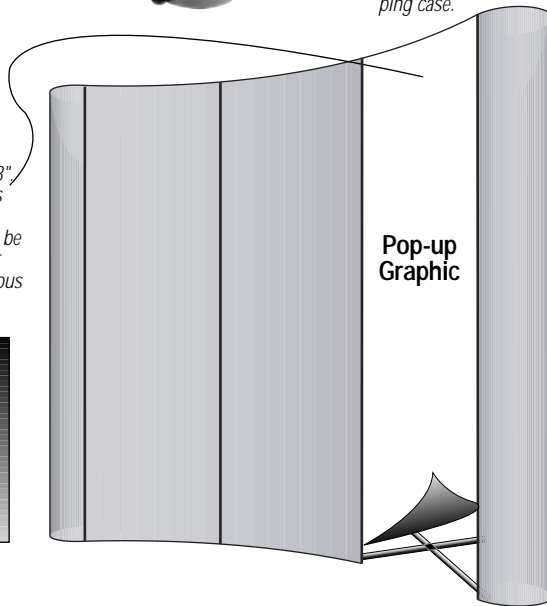
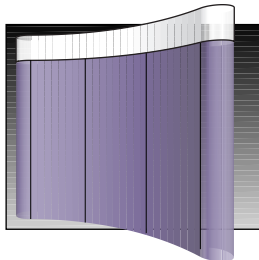

**ExpoStar®**  
Displays And Graphics

# GRAPHICS SPECIFICATIONS

## Media Accepted

(Macintosh Formatted Only)  
1.44 MB 3.5" Floppy Diskette  
100 MB Iomega Zip Disk  
1 Gigabyte Iomega Jaz Disk  
2 Gigabyte Iomega Jaz Disk  
CD Rom Disks, CD-RW (Rewritable)  
Any 3.5" Magneto Optical  
up to 640 MB

## Format Requirements

For output from your disk, supply native document at 100%, 50% or 25% of actual size in one of the following applications:

For StarFlex Digital Graphics:  
Adobe Illustrator (preferred)  
Quark XPress\*  
Macromedia Freehand\*  
Adobe Photoshop (photos)

For Vinyl Graphics  
Adobe Illustrator  
(vector art with fonts outlined)  
\*requires conversion at extra charge

Supply screen and printer fonts for each document and native versions of each file placed in the host document. Placed files must be EPS JPEG or TIFF Formats, RGB mode. Graphics files supplied in other applications may be converted or rebuilt at an extra charge. Please ask for a quote.

## Color Matching

The ExpoStar Graphics Studio is equipped with the latest technology in digital printers available in the graphics and display industry (see below). ExpoStar cannot guarantee exact color matching due to the nature of screen values that interpret color and other limitations inherent in this type of color printing equipment. We will do our best to match colors as specified, with the highest possible level of accuracy. For best results, specify color using the Tru-match color matching system. Re-printed Archived files will not exactly match original prints. Color prints that require exact color matching from one to the other must be batch printed.

## Resolution

All Photoshop or other bitmapped digital images must be supplied at a resolution of 75-100 dpi at the finish size of the graphic being produced.

## Resolution Formula

Choose smallest dimension of original image and smallest dimension of final size.

Final Size ÷ Original Size x 75 dpi = Minimum Resolution

Final Size ÷ Original Size x 100 dpi = Maximum Resolution

Example: Output final image at 44" x 55"

- 1) 4" x 5" original  $44" \div 4" = 11$        $11 \times 75 \text{ dpi} = 825 \text{ dpi} = \text{minimum}$
- 2) 2.5" x 3.5" original  $44" \div 2.5" = 18$        $18 \times 75 \text{ dpi} = 1350 \text{ dpi} = \text{minimum}$

Note: If the image is not to be used full frame, make sure that cropped dimension is used to determine resolution.



## Printers

36" LaserMaster DisplayMaker Inkjet  
50" Encad NovaJet Pro 50 Inkjet

## Scanners

Umax Mirage II 12" x 18" Flatbed Scanner  
Leaf-45 Transparency Scanner

# Partial Client Listing

AARP  
 AFLAC  
 Air Force Dept. of Investigations  
 American Institute of Bldg. Design  
 American Red Cross  
 Anchor Continental  
 AT&T Fitel  
 Atlanta Paralympics  
 Bald Head Island  
 BASF  
 Billy Graham Evangelistic Assoc.  
 British Broadcasting Corporation  
 Blue Cross/Blue Shield  
 Budget Rent-A-Car  
 Carolco Film Studios  
 Central Carolina Bank  
 CIA  
 CIBA  
 Circuit City  
 City of Los Angeles  
 City of West Hollywood  
 Classic Games Incorporated  
 Corning  
 Curious Kids Museum  
 Dixie Stampede  
 Dornier Medical Systems  
 Duke University Medical Center  
 Dun & Bradstreet  
 DuPont  
 East Carolina University  
 Egleston Children's Hospital  
 Emory University  
 Entertainment Weekly  
 Exide Corporation  
 Ezzell Trucking Company  
 Floor Coverings International  
 Florida State University  
 Foss Manufacturing  
 Fredrickson Motor Express  
 Fujitsemo, USA

General Electric  
 General Services Administration  
 Georgia Forestry Commission  
 Georgia Pacific Corporation  
 Georgia Tech  
 Girl Scout Council  
 Gourmet Magazine  
 Grand Strand General Hospital  
 Great Smokies Hotel Assoc.  
 Gregory Poole  
 GTE  
 Hampton Inn  
 HBO & Company  
 Hilton Las Vegas  
 Hiltons of the Carolinas  
 Historic Naval Ships Association  
 Hoechst-Celanese  
 Hospice  
 ILCO Unican Corporation  
 Instrument Society of America  
 Integrated Technology Corp.  
 John Hancock Financial Services  
 Johnson & Johnson  
 K-Mart  
 Kaiser Permanente  
 Kent State University  
 Kodak Chemical  
 Konica Manufacturing  
 Lifestar Memorial Medical Center  
 Los Alamos National Laboratory  
 Lucent Technologies  
 Luxor Casino  
 March of Dimes  
 Marriott Orlando World Center

Martin Marietta  
 MCI  
 Med Plus Medical Services  
 Mendocino National Forest  
 Milliken  
 Naegele Outdoor Advertising  
 National Fire & Rescue  
 National Institute of Health  
 National Park Service  
 Nat. Press Photographers Assoc.  
 National Scuba Program  
 National Small Business Council  
 Naval Subbase - Bangor Maine  
 NC Aquarium  
 NC Assoc.for Biomedical Research  
 NC Assoc.for the Gifted & Talented  
 NC Department of Commerce  
 NC Department of Crime Control  
 NC Employment Security Comm.  
 NC Public Transportation Assoc.  
 NC State Bureau of Investigation  
 NC State Port Authority  
 NC State University  
 Nickelodeon  
 Norrell Health Care  
 Novartis  
 Occidental Chemical Corporation  
 Ohio University  
 Oklahoma State University  
 Omni Richmond Hotel  
 Operation Baby Buckle  
 Overnite Trucking Company  
 OxyChem  
 Pfizer Chemical

Philadelphia Civic Center  
 Pittsburgh Paint Industries / PPG  
 Pizza Hut, Inc.  
 Reeds Jewelers  
 Research Triangle Institute  
 Rockwell International  
 Rutgers University  
 Sacred Heart Catholic Church  
 Saguaro National Monument  
 Salvation Army  
 SAS Institute, Inc.  
 SC Firefighters Association  
 Screen Gems Productions  
 Sega  
 Six Flags over Georgia  
 SmithKline Beecham  
 St. Joseph's Hospital  
 Subway Headquarters  
 The Pentagon  
 This End Up Furniture Company  
 University of Florida  
 University of Maine  
 University of Missouri  
 University of North Carolina  
 University of the Virgin Islands  
 UPS  
 USAir  
 US Army  
 US Army Corps of Engineers  
 US Fish & Wildlife  
 US Forest Service  
 US Geological Survey  
 US Marine Corps  
 USS Battleship North Carolina  
 Washington Golf Monthly  
 Wieland Corporation  
 Xiox Corporation  
 Young Indy Productions  
 Youth Service of America  
 Zion Canyon Theatre Marketing

Your Authorized Expostar Dealer

